

At: Gadeirydd ac Aelodau'r Pwyllgor
Cynllunio

Dyddiad: Dydd Iau, 12 Mehefin
2014

Rhif Union: 01824 712568

ebost: dcc_admin@denbighshire.gov.uk

Annwyl Gynghorydd

Fe'ch gwahoddir i fynychu cyfarfod y **PWYLLGOR CYNLLUNIO, DYDD MERCHER, 18 MEHEFIN 2014** am **9.30 am** yn **SIAMBR Y CYNGOR, NEUADD Y SIR, RHUTHUN LL15 1YN**.

Yn gywir iawn

G Williams
Pennaeth Gwasanaethau Cyfreithiol a Democraidaidd

AGENDA

1 YMDDIHEURIADAU

2 DATGAN CYSYLLTIAD

Aelodau i ddatgan unrhyw gysylltiad personol neu gysylltiad sy'n rhagfarnu mewn unrhyw fater a nodwyd i'w ystyried yn y cyfarfod hwn.

3 MATERION BRYD FEL Y'U CYTUNWYD GAN Y CADEIRYDD

Rhybudd o eitemau y dylid, ym marn y Cadeirydd, eu hystyried yn y cyfarfod fel materion brys yn unol ag Adran 100B (4) Deddf Llywodraeth Leol, 1972.

4 COFNODION (Tudalennau 11 - 28)

Cadarnhau cywirdeb cofnodion cyfarfod y Pwyllgor Cynllunio a gynhaliwyd 14 Mai 2014 (copi wedi'i atodi).

5 CEISIADAU AM GANIATÂD DATBLYGU (Tudalennau 29 - 80)

Ystyried y ceisiadau am ganiatâd datblygu (copïau wedi'u hatodi).

6 APÊL AMLOSGFA FFORDD GLASCOED (Tudalennau 81 - 84)

Ystyried adroddiad gan y Pennaeth Cynllunio a Gwarchod y Cyhoedd (copi wedi'i amgáu) ynglŷn ag apêl a ragwelir yn erbyn gwrthod datblygiad. Mae'r adroddiad yn rhoi gwybodaeth gefndir ac yn gofyn am gynrychiolaeth aelodau a chyfreithiol broffesiynol yn y broses apêl.

7 ADRODDIAD CYFLWYNO'R DIWEDDARAF AR APELIADAU (Tudalennau 85 - 98)

Ystyried adroddiad gan y Rheolwr Datblygu (wedi'i amgáu) sy'n darparu dadansoddiad manwl o'r holl benderfyniadau apeliadau cynllunio sydd wedi cael eu gwneud o Ebrill 2013 hyd yma.

AELODAETH

Y Cynghorwyr

Y Cynghorydd Ray Bartley (Cadeirydd)

Y Cynghorydd Win Mullen-James (Is-Gadeirydd)

Ian Armstrong
Joan Butterfield
Jeanette Chamberlain-Jones
William Cowie
Ann Davies
Meirick Davies
Richard Davies
Stuart Davies
Peter Arnold Evans
Huw Hilditch-Roberts
Colin Hughes
Rhys Hughes
Alice Jones
Pat Jones

Margaret McCarroll
Bob Murray
Peter Owen
Dewi Owens
Merfyn Parry
Arwel Roberts
David Simmons
Bill Tasker
Julian Thompson-Hill
Joe Welch
Cefyn Williams
Cheryl Williams
Huw Williams

COPIAU I'R:

Holl Gynghorwyr er gwybodaeth
Y Wasg a'r Llyfrgelloedd
Cynghorau Tref a Chymuned

CROESO I BWYLLGOR CYNLLUNIO CYNGOR SIR DDINBYCH

SUT GAIFF Y CYFARFOD EI GYNNAL

Oni bai bod Cadeirydd y Pwyllgor yn nodi i'r gwrthwyneb, bydd trefn y prif eitemau yn dilyn yr agenda a nodwyd ar flaen yr adroddiad hwn.

Cyflwyniad cyffredinol

Bydd y Cadeirydd yn agor y cyfarfod am 9.30yb ac yn croesawu pawb i'r Pwyllgor Cynllunio.

Bydd y Cadeirydd yn gofyn a oes unrhyw ymddiheuriadau dros absenoldeb a datganiadau o fuddiannau.

Bydd y Cadeirydd yn gwahodd Swyddogion i roi cyflwyniadau byr i'r eitemau ar yr agenda.

Bydd Swyddogion yn amlinellau (fel ag sy'n briodol) eitemau a fydd yn cynnwys siarad cyhoeddus, ceisiadau ar gyfer gohirio, eitemau sydd wedi'u tynnu'n ôl, ac unrhyw eitemau Rhan 2 lle bydd y wasg a'r cyhoedd yn cael eu gwahardd. Bydd cyfeiriadau at unrhyw wybodaeth ychwanegol a ddosbarthwyd yn Siambr y Cyngor cyn dechrau'r cyfarfod, gan gynnwys y taflenni sy'n crynhoi cyflwyniadau/newidiadau hwyr (taflenni glas) ac unrhyw gynlluniau atodol neu ddiwygiedig sy'n ymwneud ag eitemau i'w trafod.

Mae'r 'Taflenni Glas' yn cynnwys gwybodaeth bwysig, gan gynnwys crynodeb o ddeunydd a dderbyniwyd mewn perthynas ag eitemau ar yr agenda rhwng cwblhau'r prif adroddiad a'r diwrnod cyn y cyfarfod. Mae'r taflenni hefyd yn nodi trefn arfaethedig y ceisiadau cynllunio, sy'n cymryd i ystyriaeth unrhyw geisiadau i siarad yn gyhoeddus.

Mewn perthynas â threfn yr eitemau, bydd disgwyl i unrhyw Aelodau sydd am ddwyn eitem i'w thrafod wneud cais yn union ar ôl cyflwyniad y Swyddogion. Rhaid i unrhyw gais o'r fath fod yn gynnig ffurfiol a bydd pleidlais ar y cais.

Mae'r Pwyllgor Cynllunio yn cynnwys 30 o Aelodau Etholedig. Yn unol â phrotocol, mae'n rhaid i 50% o Aelodau'r Pwyllgor fod yn bresennol i sefydlu cworwm ac i sicrhau bod modd ystyried eitem a phleidleisio ar eitem.

Caiff Cynghorwyr Sir sydd ddim yn aelodau o'r Pwyllgor Cynllunio fynychu a siarad ar eitem, ond ni allant wneud cynnig, na phleidleisio.

YSTYRIED CEISIADAU CYNLLUNIO

Y drefn i'w dilyn

Bydd y Cadeirydd yn cyhoeddi'r eitem sydd i'w thrafod nesaf. Mewn perthynas â cheisiadau cynllunio, cyhoeddir rhif y cais, sail y cynnig a'r lleoliad, yr Aelodau lleol perthnasol ar gyfer yr ardal, ac argymhelliad y Swyddog.

Os oes yna siaradwyr cyhoeddus ar eitem, bydd y Cadeirydd yn eu gwahodd i annerch y Pwyllgor. Os oes siaradwyr yn erbyn ac o blaid cynnig, gofynnir i'r siaradwr sydd yn erbyn i siarad yn gyntaf. Bydd y Cadeirydd yn atgoffa siaradwyr bod ganddynt hyd at 3 munud i annerch y Pwyllgor. Mae gan siarad cyhoeddus ei brotocol ei hunan.

Lle bo hynny'n berthnasol, bydd y Cadeirydd yn cynnig cyfle i'r Aelodau ddarllen unrhyw wybodaeth hwyr ar yr eitem ar y 'Taflenni Glas' cyn parhau.

Os oes unrhyw Aelod am gynnig y dylid gohirio eitem, gan gynnwys ceisiadau i Banel Archwilio Safle ymweld â'r safle, dylid gwneud y cais ynghyd â'r rheswm cynllunio, cyn unrhyw siarad cyhoeddus neu drafodaeth am yr eitem honno.

Cyn unrhyw drafodaeth, bydd y Cadeirydd yn gwahodd swyddogion i roi cyflwyniad cryno i'r eitem lle credir bod hyn yn werth chweil yng ngolau natur y cais.

Mae sgriniau arddangos yn Siambr y Cyngor a ddefnyddir i ddangos ffotograffau neu gynlluniau a gyflwynir gyda cheisiadau. Cymerir y ffotograffau gan Swyddogion i roi argraff gyffredinol i Aelodau o safle a'i amgylchedd, ac nid eu bwriad yw cyflwyno achos o blaid neu yn erbyn cynnig.

Bydd y Cadeirydd yn cyhoeddi bod yr eitem yn agored am drafodaeth ac yn rhoi cyfle i Aelodau siarad a rhoi sylwadau am yr eitem.

Os oes unrhyw gais wedi bod yn destun Panel Archwilio Safle cyn y Pwyllgor, bydd y Cadeirydd fel rheol yn gwahodd yr Aelodau hynny a fynychodd, gan gynnwys yr aelod lleol, i siarad yn gyntaf.

Yn achos yr holl geisiadau eraill, bydd y Cadeirydd yn gofyn i'r aelod(au) lleol siarad yn gyntaf, os yw ef/nhw yn dymuno gwneud hynny.

Fel rheol, rhoddir hyd at bum munud i Aelodau siarad, a bydd y Cadeirydd yn llywio'r drafodaeth yn unol â Rheolau Sefydlog.

Unwaith bod aelod wedi siarad, ni ddylai ef/hi siarad eto oni bai ei fod ef/hi am esboniad o bwyntiau a gododd yn y drafodaeth, a rhaid i hynny hefyd ddigwydd ar ôl i'r holl Aelodau eraill gael cyfle i siarad, a gyda chaniatâd y Cadeirydd.

Ar derfyn trafodaeth yr Aelodau, bydd y Cadeirydd yn gofyn i Swyddogion ymateb yn ôl yr angen i gwestiynau a phwyntiau a godwyd, gan gynnwys cyngor ar unrhyw benderfyniad sy'n mynd yn groes i'r argymhelliad.

Cyn symud ymlaen at y bleidlais, bydd y Cadeirydd yn gwahodd neu'n gofyn am eglurhad o gynigion ac eilyddion i'r cynigion o blaid neu yn erbyn argymhelliad y Swyddog, neu unrhyw benderfyniadau eraill sy'n gofyn am ddiwygiadau i gynigion. Pan gaiff cynnig ei wneud yn groes i argymhelliad y Swyddog, bydd y Cadeirydd yn gofyn am eglurhad o'r rheswm/rhesymau cynllunio dros y cynnig hwnnw, er mwyn i hyn gael ei gofnodi yng Nghofnodion y cyfarfod. Mae'n bosibl y bydd y Cadeirydd yn gofyn am sylwadau gan y Swyddog Cyfreithiol a Chynllunio am ddilysrwydd y rheswm/rhesymau a nodwyd.

Bydd y Cadeirydd yn gwneud cyhoeddiad i nodi bod y drafodaeth ar ben, a bod y pleidleisio i ddilyn.

Y drefn bleidleisio

Cyn gofyn i Aelodau bleidleisio, bydd y Cadeirydd yn cyhoeddi pa benderfyniadau a wnaed a sut fydd y bleidlais yn cael ei chynnal. Gellir gofyn am esboniad pellach ynghylch newidiadau, amodau newydd ac ychwanegol a rhesymau dros wrthod er mwyn sicrhau nad oes unrhyw amwysedd yn yr hyn y mae'r Pwyllgor yn pleidleisio o'i blaid neu yn ei erbyn.

Os yw unrhyw aelod yn gwneud cais am Bleidlais wedi'i Chofnodi, mae'n rhaid ymdrin â hyn yn gyntaf yn unol â'r Rheolau Sefydlog. Bydd y Cadeirydd a Swyddogion yn egluro'r drefn i'w dilyn. Bydd enwau bob un o'r Aelodau pleidleisio sy'n bresennol yn cael eu galw allan, a bydd gofyn i'r Aelod nodi a yw eu pleidlais o blaid neu yn erbyn rhoi caniatâd neu ymwrthod. Bydd Swyddogion yn cyhoeddi canlyniad y bleidlais ar yr eitem.

Os yw pleidlais arferol i ddigwydd trwy gyfrwng y system bleidleisio electronig, bydd y Cadeirydd yn gofyn i'r Swyddogion weithredu'r sgrin bleidleisio yn y Siambr, a phan ofynnir iddynt wneud hynny, mae'n rhaid i'r Aelodau gofnodi eu pleidlais drwy bwysu'r botwm priodol.

Mae gan Aelodau 10 eiliad i gofnodi eu pleidleisiau unwaith bo'r sgrin wedi ymddangos.

Os yw'r system bleidleisio electronig yn methu, gellir cynnal y bleidlais drwy ddangos dwylo. Bydd y Cadeirydd yn esbonio'r drefn sydd i'w dilyn.

Ar derfyn y bleidlais, bydd y Cadeirydd yn cyhoeddi'r penderfyniad ar yr eitem.

Pan fydd penderfyniad ffurfiol y Pwyllgor yn groes i argymhelliad y Swyddog, bydd y Cadeirydd yn gofyn i Aelodau gytuno'r broses a ddefnyddir i ddrafftio amodau cynllunio neu resymau dros wrthod, er mwyn rhyddhau'r Tystysgrif Penderfyniad (e.e. dirprwyo awdurdod i'r Swyddog Cynllunio, i'r Swyddog Cynllunio mewn cysylltiad ag Aelodau Lleol, neu drwy gyfeirio'n ôl i'r Pwyllgor Cynllunio ar gyfer cadarnhad).

Mae tudalen hwn yn fwriadol wag

PWYLLGOR CYNLLUNIO

TREFN BLEIDLEISIO

Atgoffir yr aelodau o'r drefn i'w dilyn wrth bleidleisio i roddi neu i wrthod caniatâd cynllunio. Bydd y Cadeirydd neu'r Swyddogion yn esbonio'r drefn i'w dilyn fel y bo angen.

Unwaith y bydd y sgriniau arddangos yn y Siambr wedi eu clirio yn barod ar gyfer y pleidleisio a phan fydd y sgrîn bleidleisio yn ymddangos, bydd gan y Cynghorwyr 10 eiliad i gofnodi eu pleidlais fel a ganlyn:

Ar y bysellfwrdd pleidleisio, pwyswch y

<p>+ i RODDI caniatâd - i WRTHOD caniatâd 0 i BEIDIO â phleidleisio</p>
--

Neu yn achos eitemau Gorfodi:

<p>+ i AWDURDODI Camau Gorfodi - i WRTHOD AWDURDODI Camau Gorfodi 0 i BEIDIO â phleidleisio</p>
--

Mae tudalen hwn yn fwriadol wag

PWYLLGOR CYNLLUNIO

Cofnodion cyfarfod y Pwyllgor Cynllunio a gynhaliwyd yn Siambr y Cyngor, Neuadd y Sir, Rhuthun, ddydd Mercher 14 Mai 2014 am 9.30am.

YN BRESENNOL

Y Cynghorwyr J.R. Bartley, J A Butterfield, W L Cowie, M Ll. Davies, J.M. Davies, R J Davies, S.A. Davies, P A. Evans, H Hilditch-Roberts, C. Hughes., T.R. Hughes, P M Jones, M. McCarroll, W M Mullen-James, R M Murray, P W Owen, T M Parry, A Roberts, D Simmons, W.N. Tasker, J Thompson-Hill , J S Welch, C H Williams, C L Williams a H O Williams

HEFYD YN BRESENNOL

Pennaeth Cynllunio a Gwarchod y Cyhoedd (Graham Boase), Pen Gyfreithiwr (Cynllunio a Phrifyrdd) (Susan Cordiner), Rheolwr Datblygu (Paul Mead), Pen Swyddog Cynllunio (Ian Weaver), Swyddog Cynllunio (David Roberts), Arweinydd Tîm (Cefnogaeth) (Gwen Butler), Uwch Swyddog Cefnogaeth (Judith Williams) a'r Cyfieithydd (Catrin Gilkes). Angela Loftus (Rheolwr Cynllun Datblygu Lleol a Pholisi) Claire Macfarlane (Swyddog Cynllun Datblygu Lleol a Pholisi) a Denise Shaw (Swyddog Cynllunio - Ynni Adnewyddadwy) yn bresennol am ran o'r cyfarfod

1 YMDDIHEURIADAU

Cafwyd ymddiheuriadau am absenoldeb gan y Cynghorwyr I W Armstrong, J A Butterfield, J Chamberlain-Jones, E.A. Jones a D Owens.
(Wrth gyflwyno ei hymddiheuriadau, gofynnodd y Cynghorydd J Chamberlain-Jones am i nodyn gael ei wneud nad oedd yn gallu mynychu'r Pwyllgor Cynllunio oherwydd gwrthdaro yn ei dyddiadur gyda Panel Maethu.)

Nodwyd bod y Cynghorydd Ray Bartley wedi cymryd lle'r Cynghorydd Peter Duffy fel cynrychiolydd y Grŵp Annibynnol ar y Pwyllgor Cynllunio a hynny ar unwaith.

Atgoffwyd yr Aelodau am eu rhwymedigaeth i gynnal lefel o hyfforddiant mewn materion Cynllunio i sicrhau eu bod yn gymwys i bleidleisio ar geisiadau cynllunio. Nodwyd, fodd bynnag y gall yr Aelodau hynny heb yr hyfforddiant angenrheidiol bleidleisio ar y holl faterion eraill ar y rhaglen.

2 DATGAN CYSYLLTIAD

Dim

3 PENODI CADEIRYDD

Gofynnwyd am enwebiadau ar gyfer swydd Cadeirydd y Pwyllgor Cynllunio am y flwyddyn i ddod.

Cafodd y Cynghorydd Ray Bartley ei enwebu gan y Cynghorydd Joe Welch, a'i eilio gan y Cynghorydd Merfyn Parry.

Cafodd y Cynghorydd Win Mullen-James ei enwebu gan y Cynghorydd Joan Butterfield, a'i eilio gan y Cynghorydd Bill Tasker.

Anerchodd yr ymgeiswyr y pwyllgor a chynhaliwyd pleidlais gudd. Roedd y canlyniadau fel a ganlyn:

15 o bleidleisiau i'r Cynghorydd Ray Bartley
10 pleidlais i'r Cynghorydd Win Mullen-James

Yn unol â'r cyfansoddiad cafodd y Cynghorydd Ray Bartley ei ethol yn briodol yn Gadeirydd y Pwyllgor Cynllunio am y flwyddyn i ddod.

Cymerodd y Cynghorydd Bartley y Gadair a diolchodd i'r Pwyllgor. Canmolodd hefyd gwaith y Cynghorydd Win Mullen James yn ystod ei blwyddyn fel Cadeirydd

Diolchodd y Cynghorwyr Meirick Lloyd Davies a H Hilditch Roberts hefyd i'r Cynghorydd Win Mullen James am ei chefnogaeth yn ystod y flwyddyn ddiwethaf.

4 PENODI IS-GADEIRYDD

Gofynnwyd am enwebiadau ar gyfer swydd Is-Gadeirydd y Pwyllgor Cynllunio am y flwyddyn i ddod.

Cafodd y Cynghorydd Win Mullen-James ei enwebu fel Is-Gadeirydd gan y Cynghorydd Joan Butterfield, a'i eilio gan y Cynghorydd Bill Tasker.

Gan nad oedd unrhyw enwebiadau eraill, cafodd y Cynghorydd Win Mullen James ei ethol yn briodol yn Is-gadeirydd y Pwyllgor Cynllunio am y flwyddyn ddinesig i ddod.

5 MATERION BRYD: Dim

4 COFNODION Y CYFARFOD A GYNHALIWYD AR 16 Ebrill 2014.

Cytunwyd fel cofnod cywir:

5 CEISIADAU AM GANIATÂD DATBLYGU

Cyflwynwyd adroddiad gan y Pennaeth Cynllunio a Gwarchod y Cyhoedd (a ddosbarthwyd yn flaenorol) yn rhestru ceisiadau a gyflwynwyd ac y mae angen i'r Pwyllgor benderfynu arnynt.

PENDERFYNWYD:-

- (a) *cadarnhau argymhellion y Swyddogion, fel y maent wedi'u cynnwys yn yr adroddiad a gyflwynwyd, a rhoi neu wrthod caniatâd cynllunio, fel sy'n berthnasol, dan Ddeddf Cynllunio Gwlad a Thref 1990, Gorchymyn Cynllunio Gwlad a Thref (Datblygu Cyffredinol a Ganiateir) 1995, Deddf Cynllunio ac Iawndal 1991, Rheoliadau Hysbysebion Cynllunio Gwlad a Thref 1991 a/neu Ddeddf Cynllunio (Adeiladau Rhestredig ac Ardaloedd Cadwraeth) 1990 i'r cynigion sy'n cynnwys y ceisiadau canlynol yn unol â'r amodau a restrir yn yr atodlen a gyflwynir:-*

Cais Rhif: 12/2013/1384/PO

Lleoliad: Tir oddi ar Crud Yr Awel Clawddnewydd Rhuthun

Disgrifiad: Datblygu 0.07 hectar o dir drwy godi 2 annedd ar wahân (cais amlinellol - pob mater wedi'i gadw'n ôl)

Gofynnodd y Cynghorydd M Lloyd Davies a fyddai'r cais hwn yn effeithio ar y ddarpariaeth o dai fforddiadwy.

Cododd y Cynghorydd Colin Hughes bryderon nad oedd Sir Ddinbych wedi darparu cymaint o dai fforddiadwy â Siroedd cyfagos.

Dywedodd Ian Weaver (Pen Swyddog Cynllunio) bod y cais hwn gerbron y Pwyllgor i ganiatáu dadl ar yr union fater hwn yn dilyn apêl a ganiatawyd ar safle yng Nghyffylliog - lle cafodd tir ei isrannu ac ni ddarparwyd tai fforddiadwy. Mae'r cais hwn yn codi materion tebyg, gyda'r safle yn rhan o ardal tai ddynodedig fwy, yn y ffin ddatblygu, o'r un berchnogaeth. Dangosodd dyfarniad yr apêl yng Nghyffylliog ei bod yn bwysig delio â'r ddarpariaeth tai fforddiadwy yn gynnar, pe bai is-rannu'n digwydd.

Roedd y cais hwn am 2 dŷ, sy'n is na'r lefel sbarduno Tai Fforddiadwy, ac nid yw'n gwneud unrhyw ddarpariaeth ar gyfer manau agored ar gyfer y datblygiad mwy posibl ar hyn o bryd. Awgrymir amod i sicrhau darparu tai fforddiadwy.

Mynegodd y Cynghorwyr bryder ynglŷn â chymhlethdod tai fforddiadwy fel mater ehangach.

Cynigion:

Cynigiodd y Cynghorydd H. O. Williams y dylid RHOI caniatâd Eiliwyd hyn gan y Cynghorydd M. Parry

PLEIDLAIS:
Pleidleisiodd 22 i GANIATÁU
Pleidleisiodd 0 i WRTHOD
0 yn Ymatal

FELLY RHODDWDYD CANIATÂD

Yn amodol ar:

Cywiriad i Reswm dros Amod Rhif 6 a 7.

6. Er mwyn cydymffurfio â pholisïau tai fforddiadwy a fabwysiadwy, atal isrannu safle tai dynodedig a fyddai'n creu'r posibilrwydd o osgoi'r polisi, er mwyn sicrhau cyflenwad o dai fforddiadwy.

7. Er mwyn cydymffurfio â'r polisi mannau agored a fabwysiadwy, atal isrannu safle tai dynodedig a fyddai'n creu'r posibilrwydd o osgoi'r polisi, er mwyn sicrhau y darperir mannau agored.

Nodyn newydd a Awgrymir i'r Ymgeisydd:

Mewn perthynas ag Amodau 6 a 7 y caniatâd hwn, fe'ch cynghorir i gysylltu â'r Swyddog Cynllunio i drafod y dull i'w fabwysiadu i ddarparu Tai Fforddiadwy a Mannau Agored mewn cysylltiad â datblygu safle'r cais a'r safle tai dynodedig mwy.

Cais Rhif: 16/2013/1542/PF

Lleoliad: Ystâd Plas Llanbedr Llanbedr Dyffryn Clwyd
Rhuthun

Disgrifiad: Trawsnewid hen dŷ boeler/ tŷ gwydr yn annedd sengl
a chodi tŷ haf atodol

Cyflwynwyd sylwadau ychwanegol:

Cydbwyllgor Ymgynghorol AHNE
Cyfoeth Naturiol Cymru
Cynllunio PLP ar ran D Hughes, Carneddi, Llanbedr DC

Siaradwyr Cyhoeddus:

Mr Guy Alford (Yn erbyn)

Heriodd Mr Alford argymhelliad y swyddog, gan awgrymu y dylid cadw at y polisïau. Dywedodd Mr Alford bod y safle hwn mewn cefn gwlad agored ac AHNE ac nad yw anwybyddu polisi'r CDLI oherwydd caniatâd blaenorol yn rhesymegol. Nid yw'r datblygiad yn darparu'r tai fforddiadwy sy'n ofynnol gan Bolisi PSE4. Anogodd Mr Alford y pwyllgor i wrthod caniatâd ar y sail hon. Roedd hefyd yn pryderu y byddai'r fynedfa i'r safle hwn yn ei agor i fyny ar gyfer datblygu yn y dyfodol.

Rhys Davies (O blaid)

Siaradodd Mr Davies o blaid, gan ddatgan mewn ymateb i gyflwyniad Mr Alford, nad yw'r mynediad yn agor meysydd eraill i fyny i'w datblygu ac awgrymodd bod y perchennog wedi cyfathrebu'n dda gyda phawb dan sylw. Roedd y Pwyllgor AHNE o blaid y "dyluniad arloesol" sydd yn destun y diwygiad hwn i ganiatâd presennol. Ailadroddodd Mr Davies, gan fod caniatâd yn bodoli, y gallai'r adeilad hwn gael ei ddatblygu nawr, ond mae'r gwelliant hwn, ym marn Mr Davies, yn gynllun gwell. Mae'n addasiad sensitif yn cyflwyno elfennau i adlewyrchu hanes hwn fel tŷ gwydr. Byddai'r ystafell ardd fechan arfaethedig yn llai na'r garej sengl ac nid oedd unrhyw fwriad i ailddatblygu'r hwn.

Mynegodd y Cynghorydd H O Williams gefnogaeth i bryderon a godwyd gan Mr Alford. Roedd y Cynghorydd Williams wedi treulio llawer iawn o amser ar faterion Plas Llanbedr, a dywedodd nad oedd pobl leol eisiau i fynedfa gael ei hadeiladu, ond roedd hyn yn rhan o'r penderfyniad apêl a wrthdrödd y

penderfyniad i wrthod yn 2011. Roedd yn pryderu am y golled arfaethedig o goed ac ni fyddai'n gallu cefnogi'r cais.

Gofynnodd Aelodau eraill a oedd seiliau cynaliadwy dros wrthod; a ellid wynebu'r ffordd newydd â deunydd nad yw'n adlewyrchu er mwyn toddi'n well i ochr y mynydd; ac oedran y coed sydd i'w torri.

Ymatebodd y swyddogion i esbonio fod y safle wedi caniatâd cynllunio ond awgrymwyd dylai'r dyddiad cychwyn fod yr un fath â'r caniatâd sy'n bodoli i osgoi cynyddu oes y caniatâd cynllunio. Roedd y coed i'w torri yn cynnwys rhai aeddfed i'r de o'r adeilad. Y bwriad yw cadw un goeden Ywen, yr amcangyfrifir iddi fod yn 188 mlwydd oed ond roedd un debyg y byddai'n rhaid ei thorri am ei bod mor agos i'r adeilad.

Roedd y fynedfa eisoes wedi cael ei chymeradwyo ond byddai swyddogion yn gofyn am fanylion y deunyddiau sydd i'w defnyddio. Mae'r CDLI yn ei gwneud yn ofynnol i ddarparu tai fforddiadwy, ond mae'r caniatâd sy'n bodoli yn seiliedig ar y polisi blaenorol yn gorbwysu'r gofyniad hwnnw.

Cynigion:

Cynigiodd y Cyng H O Williams WRTHOD caniatâd ar y sail nad yw'r cynnig yn cydymffurfio â gofyniad Polisi PSE 4 i ddarparu tai fforddiadwy ac effaith annerbyniol y tŷ haf arfaethedig tu allan i'r cwrtil, o fewn yr AHNE. Eiliwyd hyn gan y Cynghorydd H Hilditch Roberts.

AR ROI'R CAIS I'R BLEIDLAIS:

Pleidleisiodd 8 i GANIATÁU

Pleidleisiodd 12 i WRTHOD

1 yn Ymatal

FELLY GWRTHODWYD CANIATÂD

Gwnaed y penderfyniad, yn groes i argymhelliad y Swyddogion, ar y sail bod y cynigion yn groes i bolisi'r Cynllun Datblygu Lleol.

Y rhesymau a ddrafftwyd -

1. Ym marn yr Awdurdod Cynllunio Lleol, nid yw'r cynigion yn cydymffurfio â phrawf ii Polisi PSE4 o Gynllun Datblygu Lleol Sir Ddinbych o ran nad yw'r anedd yn cael ei chynnig fel uned fforddiadwy i ddiwallu anghenion lleol, ac felly ni fyddai'n cyfrannu at gyflawni tai fforddiadwy yn unol â strategaethau'r Cyngor.
2. Nid yw'r cynnig i ymestyn y cwrtil preswyl tu hwnt i'r hyn a gymeradwywyd fel rhan o'r caniatâd cynllunio sy'n bodoli 16/2009/1155/PF, gan gynnwys datblygu tŷ haf ar wahân, yn cael ei ystyried yn dderbyniol mewn egwyddor ac o ran effaith ffisegol o ran Polisi VOE2 o Gynllun Datblygu Lleol Sir Ddinbych gan y

byddai'n cael effaith weledol annerbyniol ac yn achosi niwed annerbyniol i gymeriad ac ymddangosiad y dirwedd o fewn Ardal o Harddwch Naturiol Eithriadol Bryniau Clwyd a Dyffryn Dyfrdwy.

Bydd y rhesymau dros wrthod yn cael eu cytuno gyda'r cynigydd a'r eilydd, Cadeirydd ac Is-Gadeirydd y Pwyllgor.

Cais Rhif: 18/2014/0303/TP

Lleoliad: 11 Parc Tyn Llan Llandyrnog Dinbych

Disgrifiad: Torri coeden sycamorwydden Rhif T1 a thocio coed sycamor a llwyfen gan 30 y cant yn Ardal G1 a ddangosir ar y cynllun a atodir i Orchymyn Cadw Coed Cyngor Dosbarth Glyndwr 1996

Dosbarthwyd cynllun cliriach.

Trafodaeth Gyffredinol:

Doedd gan y Cyng Merfyn Parry ddim gwrthwynebiad a chynigwyd CANIATÁU argymhelliad y Swyddogion. Eiliwyd hyn gan y Cyngorydd H Hilditch Roberts.

PLEIDLAIS:

Pleidleisiodd 22 i GANIATÁU

Pleidleisiodd 0 i WRTHOD

0 yn Ymatal

FELLY RHODDWDYD CANIATÂD

Cais Rhif: 45/2014/0193/PF

Lleoliad: Tir yn cyffinio â 21 Stanley Park Avenue, Y Rhyl

Disgrifiad: Codi garej ddwbl unllawr a tho ar ongl.

Dywedodd y Cynghorydd Bill Tasker nad oedd ganddo unrhyw wrthwynebiad mewn egwyddor, ond gofynnodd am i'r safle gael ei fonitro er mwyn sicrhau nad yw'r ymgeisydd yn ei ddefnyddio i storio deunyddiau adeiladu ar gyfer ei fusnes. Gofynnodd y Cyngorwyr eraill am eglurhad ar y rheolau sy'n ymwneud â busnesau yn y cartref. Eglurodd swyddogion os caiff amwynder preswyl ei newid gan y gweithgaredd neu bod y cydbwysedd yn fwy tuag at y busnes, byddai angen caniatâd. Byddai'n bwysig adolygu gweithgareddau.

Dywedodd y Cyng W Mullen James wrth y Pwyllgor bod parcio yn broblem yn yr ardal hon a dylid gosod cyfyngiadau ar storio cerbydau a pheiriannau mawr.

Cyfeiriodd y swyddogion y pwyllgor at Amod 3 a oedd yn cynnwys gweithgareddau masnachol.

Cynigiodd y Cyng Bill Tasker y dylid **RHOI CANIATÂD**. Eiliwyd hyn gan y Cynghorydd M. Lloyd Davies.

PLEIDLAIS:
Pleidleisiodd 22 i GANIATÁU
Pleidleisiodd 0 i WRTHOD
0 yn Ymatal

Felly rhoddwyd CANIATÂD

EITEM 8

AILYSTYRIED CAIS CYNLLUNIO

NEWID DEFNYDD BWYTY AR LEFEL LLAWR CYNTAF I 2 FFLAT HUNANGYNHWYSOL

72 QUEEN STREET, Y RHYL

CAIS RHIF. 45/2014/0116/PF

Cyflwynwyd: adroddiad gan y Pennaeth Cynllunio a Gwarchod y Cyhoedd

Eglurodd Paul Mead, y Rheolwr Datblygu, yr amgylchiadau a arweiniodd at wrthod caniatâd yn y Pwyllgor diwethaf, a chais y Swyddogion am adolygu'r penderfyniad

Pryderon priffyrdd a roddwyd fel y rheswm dros wrthod ond yn dilyn trafodaethau gyda Swyddogion Priffyrdd roedd yn amlwg, o ystyried lleoliad y safle ger canol y dref gyda meysydd parcio lleol addas, nad oedd hyn yn rheswm cynaliadwy ar gyfer gwrthod y cais. Ymgynghorwyd hefyd â Thîm y Rhyl yn Symud Ymlaen ac roeddent yn gyfforddus gyda'r datblygiad hwn - gan ddweud y byddai ffocws yn y dyfodol ar gyfer adeiladau busnes yn cael ei gyfyngu i ardal lai o ganol y dref, ac y byddai'r eiddo hyn ar y cyrion a fyddai'n fwy preswyl o ran eu natur.

Ailadroddodd y Cynghorydd J Butterfield ei farn bod y gwaith o ddymchwel tai yn y Rhyl yn creu problem ac yn teimlo nad yr ardal hon yn addas ar gyfer fflatiau.

Roedd y Cynghorydd Bill Cowie yn meddwl y byddai trigolion posibl yn ystyried a oedd parcio yn broblem iddynt cyn symud i mewn i eiddo o'r fath a dywedodd y byddai'n well ganddo iddo gael ei feddiannu na'i adael yn wag.

Cytunodd y Cyng M Parry gyda'r Cynghorydd Cowie a gofynnodd am i wneud yr adeilad yn un gwrthsain i amddiffyn trigolion rhag sŵn o'r bwyty.

Eglurodd swyddogion fod y bwyty i'w drawsnewid ar y llawr cyntaf a bod cyfyngiadau polisi ar ddefnyddio siopau llawr gwaelod ar gyfer dibenion preswyl, felly ni ddylai sŵn o fwyty sydd ar agor yn hwyr fod yn broblem.

Cynigiodd y Cynghorydd M. Ll. Davies y dylid RHOI CANIATÂD. Eiliwyd hyn gan y Cynghorydd Bill Cowie

Cynghorwyd y rhai sy'n bwriadu pleidleisio yn erbyn y cynnig hwn yn gryf gan Graham Boase, Pennaeth Cynllunio a Gwarchod y Cyhoedd, i ddatgan eu rhesymau am hynny cyn mynd i'r bleidlais.

Cynigiodd y Cyng J Butterfield WRTHOD caniatâd, am y rheswm y byddai colli eiddo masnachol yn niweidiol. Eiliwyd hyn gan y Cynghorydd Bob Murray.

AR ROI'R CAIS I'R BLEIDLAIS:

Pleidleisiodd 13 i GANIATÁU

Pleidleisiodd 8 i WRTHOD

1 yn Ymatal

Felly, **RHODDWDYD CANIATÂD** yn unol ag argymhelliad y swyddogion

, yn amodol ar ychwanegu'r amod cynllunio canlynol:

3. Ni chaniateir preswyllo yn yr un o'r fflatiau nes y cyflwynir ac y cymeradwyir yn ysgrifenedig gan yr Awdurdod Cynllunio Lleol, gyfleusterau ar gyfer parcio beiciau yn ddiogel o fewn y safle, a bod y trefniadau a gymeradwywyd wedi cael eu rhoi ar waith.

Rheswm - Er mwyn sicrhau trefniadau boddhaol ar gyfer parcio beiciau er budd hygyrchedd.

EITEM 9
PROSIECT ISADEILEDD MAWR CYSYLLTIADAU FFERMYDD
GWYNT GOGLEDD CYMRU
YMGYNGHORIAD O DAN ADRAN 42 O DDEDDF CYNLLUNIO
2008

Roedd Denise Shaw (Swyddog Cynllunio Ynni Adnewyddadwy) yn bresennol ar gyfer yr eitem hon.

Eglurodd Denise Shaw bod yr adroddiad hwn yn ymwneud ag ymgynghori cyn cyflwyno cais cynllunio i'r Arolygiaeth Gynllunio ar gyfer llinellau pŵer trydan uwchben o Glocaenog i Lanelwy. Mae Cyngor Sir Ddinbych yn un o'r Ymgynghoreion Statudol. Mae'r adroddiad hefyd yn gofyn am benderfyniad ynghylch dyrannu adnoddau ymroddedig i ymateb i'r prosiect pan fydd y cais yn cael ei gyflwyno. Mae'r cyfnod ymgynghori ar gyfer ymateb wedi cael ei ymestyn hyd at fis Mehefin 2014.

Siaradodd y Cynghorydd Joe Welch yn helaeth ar yr ymgynghoriad annigonol yn ei ward, gan gynnwys eiddo, Tan yr Allt, o fewn 25m i'r llinell arfaethedig nad oedd wedi'i gynnwys yn yr ymgynghoriad. Cyfeiriodd hefyd at anghywirdeb y diagramau safbwynt a gyflwynwyd. Roedd nifer o eiddo ym Mheniel a Saron wedi ei adael allan o'r ymgynghoriad ac roedd yn rhaid ailadrodd yr ymarfer. Roedd barn leol gryf y byddai peilonau mawr yn cael effaith andwyol ar dwristiaeth a'r dirwedd, ac anogodd i'r ceblau gael eu gosod o dan y ddaear.

Cytunodd y Cynghorwyr eraill, gan ddweud bod ceblau wedi cael eu gosod o dan y ddaear o'r arfordir i Lanelwy, ac y dylai ymateb y Cyngor gynnwys (ar 4.2b) "dylai'r llwybr cyfan fod o dan y ddaear" ac nid "y rhan fwyaf o'r llwybr". Mynegwyd siom na chafodd Coetir Hynafol ei adnabod fel bod yn llwybr y peilonau ac y byddai'r golygfeydd wrth y porth i Sir Ddinbych (ar Ffordd Groes) gael eu heffeithio gan beilonau yn croesi ar y pwynt hwn.

Dywedodd Denise Shaw fod y rhain yn bwyntiau dilys ond cynghorodd ar gyfer llinellau uwchben oedd y cynnig ac yn yr Ymchwiliad byddai angen amddiffyn yn gadarn pam nad yw llinellau uwchben yn dderbyniol.

Tynnwyd sylw hefyd at y ffaith bod Cyngor Sir Ddinbych yn un o nifer o ymgynghoreion ac y dylai ymgynghoreion eraill (gan gynnwys aelodau o'r cyhoedd) gyhoeddi ymateb eu hunain.

Ar y pwynt hwn, cynigiodd y Cynghorydd Colin Hughes gynnwys neges gref gan nodi dewis y Cyngor i'r ceblau gael eu gosod o dan y ddaear. Eiliwyd hyn gan y Cynghorydd J Butterfield a chytunwyd yn unfrydol trwy godi dwylo.

Parhaodd yr Aelodau â'r ddadl, gan godi'r materion canlynol:

- gofyn am i siroedd cyfagos a effeithir arnynt gael gwybod am farn Sir Ddinbych er mwyn cael eu cefnogaeth.
- nodi bod meysydd magnetig yn cael eu hallyrru o geblau tanddaearol a dylid cymryd hyn i ystyriaeth
- dylid defnyddio cost fel rhan o'r ddadl.
- y bydd effaith ar fywyd gwyllt.

Cyfeiriodd Swyddogion yr Aelodau at yr argymhelliad ar yr Adroddiad Atodol a fyddai'n cael ei ailddrafftio a'i rannu gydag Aelodau Lleol, y Cadeirydd a'r Is-gadeirydd cyn iddo gael ei roi i SPManweb fel ymateb y Cyngor.

Cafwyd cynnig pellach gan y Cynghorydd D Simmons y dylai pawb sy'n gysylltiedig ysgrifennu at eu AS/ AC yn rhoi gwybod iddynt am bryderon eu hetholwyr. Eiliwyd hyn gan y Cyng Colin Hughes a'i dderbyn yn unfrydol drwy godi dwylo.

Cynigiodd y Cyng Arwel Roberts dderbyn argymhelliad y Swyddogion, yn amodol ar yr ychwanegiadau a awgrymwyd gan y Pwyllgor. Eiliwyd hyn gan y Cynghorydd Bill Cowie

AR ROI'R CAIS I'R BLEIDLAIS:

Pleidleisiodd 23 i dderbyn argymhellion yr adroddiad

0 wedi pleidleisio yn erbyn

Nid oedd neb yn ymatal

Diolchwyd i Denise Shaw am y sesiwn briffio Aelodau diweddar a'i gwaith ar y mater hwn.

EITEM 10

CANLLAW CYNLLUNIO ATODOL TAI FFORDDIADWY - MABWYSIADU'R DDOGFEN DERFYNOL

Roedd Angela Loftus a Claire Macfarlane (Adran Cynllun Lleol a Pholisi) yn bresennol ar gyfer yr eitem hon.

Esboniodd Angela Loftus y cefndir i'r eitem hon, gan hysbysu'r Aelodau o'r rheswm dros ostwng y gofyniad am dai fforddiadwy i 10% o'r anheddau arfaethedig ond pwysleisiodd y gall hyn godi i 30% os bydd y farchnad dai adfer. Byddai swyddogion yn monitro costau adeiladu, incwm a phrisiau tai yn flynyddol.

Mae datblygiadau llai yn gofyn am gyfraniad ariannol, ac mae manylion y rhain wedi cael eu cynnwys yn y CCA.

Lleisiodd yr aelodau'r farn bod

- Ni ymdriniwyd â Tai Fforddiadwy yn iawn yn Sir Ddinbych, mae'r "tâp coch" yn ei gwneud yn anodd i fynd ar y rhestr aros ond roedd y rhestr yn cael ei defnyddio fel dangosydd o angen am dai fforddiadwy mewn ardal benodol.
- Roedd yr elfen "Cysylltiad Lleol" yn rhy gaeth.
- Mae prisiau tai cyfartalog mewn rhai lleoliadau yn uchel, felly nid oes llawer o gyfleoedd i bobl ifanc aros. Mae niferoedd disgyblion ysgol yn gostwng o ganlyniad.
- Nid yw angen ariannol yn angenrheidiol ar gyfer y polisi pentrefannau.
- Dylai Cyngor Sir Ddinbych fod yn 'agored ar gyfer tai' yn ogystal ag 'agored ar gyfer busnes.'

Ymatebodd y swyddogion trwy gynghori eu bod yn deall y problemau o ran cael mynd ar y rhestr aros ac y buasent yn adrodd yn ôl i gydweithwyr yn yr Adran Tai.

- Mae'r polisi Pentrefannau wedi ei anelu at gadw teuluoedd ifanc lleol.
- Mae angen ariannol yn ganolog i'r polisi hwn.
- Rhaid cael rhywfaint o reolaeth dros adeiladu tu allan i ffiniau datblygu.
- Os yw'r Aelodau'n ystyried y CCA yn ddiffygiol yna dylid ei wrthod a'i ailddrafftio.
- Diffyg cyfathrebu clir - Bydd swyddogion yn ceisio trafod gyda'r Pennaeth Tai, Swyddogion Tai a staff Cynllunio perthnasol i drafod materion yn fanwl.
- Mae'r Cynllun Datblygu Lleol yn cael ei adolygu o fis Mehefin 2014 felly gellir rhoi sylw i faterion bryd hynny.

Cynigiodd y Cynghorydd Stuart Davies dderbyn y CCA Tai Fforddiadwy yn unol â'r adroddiad yn amodol ar waith pellach ar y polisi Tai Fforddiadwy yn ystod yr

adolygiad o'r CDLI sy'n dechrau ym Mehefin 2014, ynghyd â'r polisïau cysylltiedig. Trafodaethau i'w cynnal rhwng Swyddogion Tai a Chynllunio ar y mater ehangach o Dai Fforddiadwy yn Sir Ddinbych a'r Aelodau i gael cynnig cyfleoedd i gymryd rhan mewn sesiynau hyfforddi ar bynciau perthnasol.

Eiliwyd hyn gan y Cynghorydd H Hilditch Roberts.

AR ROI'R CAIS I'R BLEIDLAIS:
Pleidleisiodd 22 o blaid y cynnig hwn
1 wedi pleidleisio yn erbyn
Nid oedd unrhyw ymatal.

Felly PENDERFYNWYD bod y Canllawiau Cynllunio Atodol terfynol arfaethedig ar Dai Fforddiadwy yn cael ei fabwysiadu ar gyfer eu defnyddio wrth benderfynu ar geisiadau cynllunio.

Bod tai fforddiadwy a pholisïau cysylltiedig o fewn y Cynllun Datblygu Lleol mabwysiedig yn destun trafodaeth bellach gydag Aelodau, o bosibl drwy gyfrwng sesiynau hyfforddi gyda Swyddogion o Tai, Cynllunio a gwasanaethau perthnasol eraill

EITEM 11
CYN YSBYTY GOGLEDD CYMRU

Datblygu Briff Dylunio - Cynnig ar gyfer Mabwysiadu

Cyflwynodd Angela Loftus yr eitem hon, gan egluro bod y cyfnod ymgynghori 8 wythnos yn cynnwys post sylweddol ac arddangosfeydd yn y llyfrgell Dinbych.

Mae'r Briff Dylunio Datblygu arfaethedig yn ymagwedd ragweithiol i ddiogelu'r Adeilad Rhestredig pwysig hwn, gan gynnwys y datblygiad galluogi isafswm i gynhyrchu digon o incwm i dalu am y gwaith angenrheidiol.

Mae hefyd yn diogelu amrywiol olygfannau pwysig o'r adeilad ac yn sefydlu fframwaith ar gyfer ystyried cynigion yn y dyfodol.

Cynigiodd y Cynghorydd D Simmons fabwysiadu Briff Dylunio Datblygu Cyn Ysbyty Gogledd Cymru.

Eiliwyd hyn gan y Cyng Win Mullen James

AR ROI'R CAIS I'R BLEIDLAIS:

20 yn pleidleisio i gytuno

Pleidleisiodd 3 yn erbyn

0 yn ymatal

PENDERFYNWYD felly mabwysiadu'r Briff Datblygu Safle arfaethedig: Cyn Ysbyty Gogledd Cymru Dinbych i'w defnyddio mewn trafodaethau cyn cyflwyno ac, o ganlyniad, wrth benderfynu ar geisiadau cynllunio

Daeth y cyfarfod i ben am 12.45 p.m.

Mae tudalen hwn yn fwriadol wag

DENBIGHSHIRE COUNTY COUNCIL
PLANNING COMMITTEE
INDEX TO REPORT

Item No	Application No	Location and Proposal	Page No
1	18/2014/0225/PF	The Creamery Llandyrnog Denbigh Erection of 6no. silos and associated engineering works	29
2	43/2013/1318/PF	Plas Deva Caravan Park Ffordd Talargoch Meliden Prestatyn Change of use of land for the siting of up to 43 park homes for permanent residential occupation including access improvements and retention of existing building for site managers accommodation	37
3	43/2014/0013/PS	Prestatyn Football Club Bastion Gardens Prestatyn Variation of condition no. 2 of planning permission code no. 43/2008/0072 to permit the use of the floodlights between 1430hrs and 2200hrs on no more than 3 days in any 7 day period	51
4	31/2014/0432/PF	Land south of St. Asaph Business Park (south) Glascoed Road St. Asaph Continued use of land as a construction compound for up to 5 years to be used in association with Burbo Bank extension onshore works	59
5	46/2014/0438/PC	7 Deans Walk St Asaph Retention of garden storage shed (retrospective application)	71

Mae tudalen hwn yn fwriadol wag

Heading:

REFERENCE NO. 18/2014/0225/PF
THE CREAMERY
LLANDYRNOG

Graham Boase
Head of Planning & Public Protection
Denbighshire County Council
Caledfryn
Smithfield Road
Denbigh
Denbighshire LL16 3RJ
Tel: 01824 706800 Fax: 01824 706709

 Application Site



Date 3/6/2014
Centre = 310946 E 365682 N

Scale 1/1250

This plan is intended solely to give an indication of the LOCATION of the application site which forms the subject of the accompanying report. It does not form any part of the application documents, and should not be taken as representative of the proposals to be considered, which are available for inspection prior to the meeting.

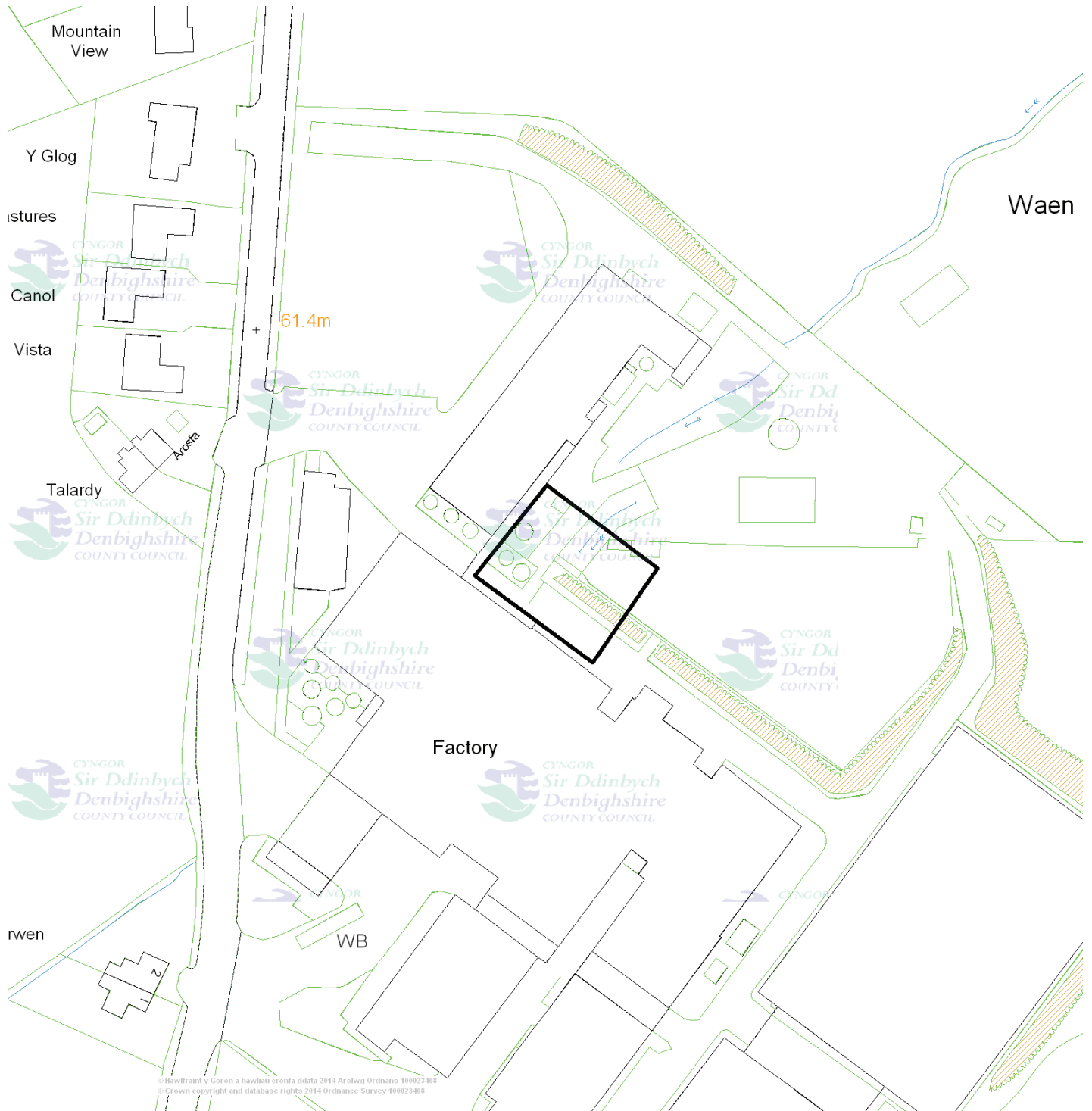

© Hawlfraint y Goron a hawliau cronfa ddata 2014 Arolwg Ordnamo 100023408
© Crown copyright and database rights 2014 Ordnance Survey 100023408

ITEM NO: 1
WARD NO: Llandyrnog
WARD MEMBER(S): Cllr Mervyn Parry
APPLICATION NO: 18/2014/0225/ PF
PROPOSAL: Erection of 6no. silos and associated engineering works
LOCATION: The Creamery Llandyrnog Denbigh
APPLICANT: Mr Nigel Tynan Arla Foods
CONSTRAINTS:
PUBLICITY Site Notice – No
UNDERTAKEN: Press Notice – No
Neighbour letters - Yes

REASON(S) APPLICATION REPORTED TO COMMITTEE:
Scheme of Delegation Part 2

- Recommendation to grant / approve – 4 or more objections received

CONSULTATION RESPONSES:

LLANDYRNOG COMMUNITY COUNCIL

"Whilst being supportive of the application there was no environmental impact assessment included with the application and no mention of noise levels generated - presumably there will be pumps associated with the silos. Would DCC expect an environmental impact survey with a development of this type - we'll let you answer that.

Officers therefore need to be satisfied that the levels of noise generated will not be detrimental to the amenity of the local residents and what measures are being put in place to ensure that their amenity is protected.

It is a major employer and investment is welcomed - but one must not forget local resident's amenity - whilst most factories shut about six this plant operates 24/7 the noise levels being the same day and night.

There is also an existing planning permission for balancing tanks - an onsite waste attenuation system to regulate the flow of waste to the local treatment plant and Members would prefer if the silos could be delayed until such time as the balancing tanks have been installed - whether this is a planning issue is debatable - your comments on this would be appreciated but we have every faith in the planning system that there is a compromise somewhere which will allow this permission to be granted.

The visual impact from the AONB can be minimised by ensuring the silos are suitably coloured - from Llandyrnog CC point of view that particular aspect is not an issue".

NATURAL RESOURCES WALES (NRW)

No objection.

DENBIGHSHIRE COUNTY COUNCIL CONSULTEES –

Head of Highways and Infrastructure

- Highways Officer

No objection.

- Public Protection Officer

No objections. Suggests inclusion of a suitably worded condition requiring the carrying out of a noise survey and restrictions on the noise levels which may be generated from the development.

RESPONSE TO PUBLICITY:

In objection

Representations received from:

P. Knight, Argoed, Llandyrnog (N)

Mr. & Mrs. J. & M. Williams, Y Glog, Llandyrnog (O) – Petition with 11 signatures

Summary of planning based representations in objection:

Amenity considerations- proposals may increase noise levels on a site where there are existing noise issues.

EXPIRY DATE OF APPLICATION: 15/04/14

REASONS FOR DELAY IN DECISION (where applicable):

- Additional information requested
- awaiting consideration by Committee

PLANNING ASSESSMENT:

1. THE PROPOSAL:

1.1 Summary of proposals

1.1.1 The application proposes the erection of six silos at Llandyrnog Creamery. These are proposed for storing water recovered during the cheese making process for use in the factory and for heat recovery.

1.1.2 The proposed silos would be sited to the north east of the existing complex. They range in height from 18.8 metres to 16.6 metres. The silos would be finished in a forest green colour. They would be sited on concrete slabs surrounded by a brick wall.

1.2 Description of site and surroundings

1.2.1 The creamery is located on the northern end of Llandyrnog village. It is a well-established cheese making enterprise.

1.2.2 The creamery comprises of a range of large industrial type buildings and some existing silos.

1.3 Relevant planning constraints/considerations

1.3.1 The site is located outside the development boundary of Llandyrnog, in the open countryside.

1.4 Relevant planning history

1.4.1 There have been various applications for developments on the site, the most recent application being for 'balancing tanks' in 2011. This development has not been implemented to date.

1.5 Developments/changes since the original submission

1.5.1 Following the consultation process additional information was sought by Officers regarding on the operation of the silos and noise details.

1.6 Other relevant background information

- 1.6.1 The Design and Access Statement refers to the need for the silos, the two largest silos would be used for the storage of water which will be recovered during the cheese making process. This water would be treated and used in the creamery for cleaning etc reducing the water needs on site and discharging from the site. The smaller silos would be used for heat recovery which would improve efficiency and reduce energy demands on site.
- 1.6.2 Noise data has been provided for the plant and pumps required for the silos.

2. DETAILS OF PLANNING HISTORY:

- 2.1 Various planning application for ancillary developments, the most recent is set out below.
18/2011/1513 Installation of balancing tanks and bund. Granted under delegated powers.
07/03/2012.

3. RELEVANT POLICIES AND GUIDANCE:

The main planning policies and guidance are considered to be:
Denbighshire Local Development Plan (adopted 4th June 2013)
Policy PSE 5 - Rural Economy

- 3.1 Supplementary Planning Guidance
N/A

- 3.2 Government Policy / Guidance
Planning Policy Wales Edition 6

4. MAIN PLANNING CONSIDERATIONS:

In terms of general guidance on matters relevant to the consideration of a planning application, Planning Policy Wales Edition 6, 2014 (PPW) confirms the requirement that planning applications 'should be determined in accordance with the approved or adopted development plan for the area, unless material considerations indicate otherwise' (Section 3.1.2). PPW advises that material considerations must be relevant to the regulation of the development and use of land in the public interest, and fairly and reasonably relate to the development concerned., and that these can include the number, size, layout, design and appearance of buildings, the means of access, landscaping, service availability and the impact on the neighbourhood and on the environment (Sections 3.1.3 and 3.1.4).

The following paragraphs in Section 4 of the report therefore refer to the policies of the Denbighshire Local Development Plan, and to the material planning considerations which are considered to be of relevance to the proposal.

- 4.1 The main land use planning issues in relation to the application are considered to be:

- 4.1.1 Principle
- 4.1.2 Visual Amenity
- 4.1.3 Residential Amenity
- 4.1.4 Highways Safety

- 4.2 In relation to the main planning considerations:

- 4.2.1 Principle
Planning Policy PSE 5 outlines the general intent of the Local Development Plan to help sustain the rural economy, through the support of tourism and commercial development, subject to detailed criteria relating to the character and distinctive qualities of the local landscape.

The application proposes ancillary development at an existing rural commercial enterprise which would be acceptable under policy PSE 5. The detailed impacts are set out below.

4.2.2 Visual amenity

In referring to what may be regarded as material considerations, Planning Policy Wales 3.1.4 refers to the number, size, layout, design and appearance of buildings, the means of access, landscaping, service availability and the impact on the neighbourhood and on the environment. The impact of a development on visual amenity is therefore a relevant test on planning applications. This is emphasised in Paragraph 3.1.7, which states that proposals should be considered in terms of their effect on the amenity and existing use of land and buildings in the public interest.

Six silos are proposed, these would be sited on the north eastern side of the complex, to the rear of one of the factory buildings on a piece of land formally used for car-parking. The largest silo would be 18.8 metres in height. The existing buildings range from single storey height up to approximately 15 metres, there are also existing silos on the site. The proposed silos would be finished in a forest green shade to match the existing buildings on the site.

Considering the scale of the development in relation to the existing factory complex, the proposed siting and finish, it is considered that the proposal would not conflict with planning policy relating to impact on the visual amenity of the area.

4.2.3 Residential amenity

Planning Policy Wales 3.1.4 refers to the number, size, layout, design and appearance of buildings, the means of access, landscaping, service availability and the impact on the neighbourhood and on the environment as potentially material considerations. The impact of a development on residential amenity is therefore a relevant test on planning applications. This is emphasised in Paragraph 3.1.7, which states that proposals should be considered in terms of their effect on the amenity and existing use of land and buildings in the public interest. As the Courts have ruled that the individual interest is an aspect of the public interest, it is therefore valid to consider the effect of a proposal on the amenity of neighbouring properties.

The application proposes the erection of six silos which will be used for purposes ancillary to the existing operation of the creamery, to improve environmental impacts and energy efficiency. The silos will not lead to an increase in production levels. Some plant is proposed as part of the proposal, for pumping water into the silos, the noise details of which have been submitted with the application. Public Protection Officers have been consulted on the application and have raised no objection to the scheme subject to a planning condition. Concerns have been raised locally over the noise impacts of the scheme.

Officers consider that the proposal would bring environmental improvements and would not increase activity at the factory including additional deliveries. Having regard to concerns over noise issues, the Pollution Control officer has no objections to the silo development, which may act to suppress sound from the existing building, but suggests the inclusion of a suitable condition requiring a noise survey and restrictions on noise levels from the silos. It is considered that the application raises no policy conflict in terms of residential amenity.

4.2.4 Highway Safety

Planning Policy Wales 3.1.4 refers to what may be regarded as material considerations and that these can include the number, size, layout, design and appearance of buildings, the means of access, landscaping, service availability and the impact on the neighbourhood and on the environment. The acceptability of means of access is therefore a standard test on most planning applications.

The access arrangements to the site remain as existing. Having regard to the specific proposals, the Highways Officers raise no objections to the application.

It is not considered that that the proposal would result in highway safety issues.

4.3 Other matters

The Community Council have questioned why an Environmental Impact Assessment has not been submitted in support of this application. Officers have considered this issue as part of the processing of the application and that with regard to the Regulations, and advise that the

development would does not require the submission of an EIA. Queries have also been raised over the timing of the previous planning permission; strictly speaking this is not directly related to this application, as it will not impact on productivity levels or increase waste water from the site; however the Agent has advised that the planning permission for the balancing tanks is likely to be implemented in 2015.

5. SUMMARY AND CONCLUSIONS:

5.1 It is the opinion of Officers that the proposal would allow for environmental improvements at an existing enterprise, complying with policy PSE 5. The application is recommended for grant.

RECOMMENDATION: GRANT – with the following conditions:-

1. The development hereby permitted shall be begun before the expiration of five years from the date of this permission.
2. No work shall be permitted to commence on the installation of the plant and equipment associated with the silos until :
 - a) There has been undertaken, at the applicant's expense, a noise assessment by a suitably qualified acoustic consultant, to assess the current noise climate and the impact that the proposed plant will have on it, including recommendations for maximum noise levels permissible in association with the operation of the silos ;
 - b)The noise assessment has been submitted to the Local Planning Authority; and
 - c) The written approval of the Local Planning Authority has been obtained to the report and its recommendations.

The reasons for the conditions are:

1. To comply with the provisions of Section 91 of the Town and Country Planning Act 1990.
2. The development shall only be permitted to operate within the noise levels as set out in the report as approved by the Local Planning Authority.

This drawing is to be used for planning purposes only.
No guarantee is given for the accuracy of the plan.

LAYOUT

Plus Deyo Park, Fford Talargoch,
Prestatyn, Wales

Flannigan Estates Limited

Proposed Site Layout Plan

Planning Application No.	12/2001	Date	28.03.2014
FIAS4.2.002		Scale	1:4

Knights
1759

Plot 2, Brynawel, Northop, Flintshire, CH74 5JL
T: 01753 710221 F: 01753 710222 www.knights.co.uk

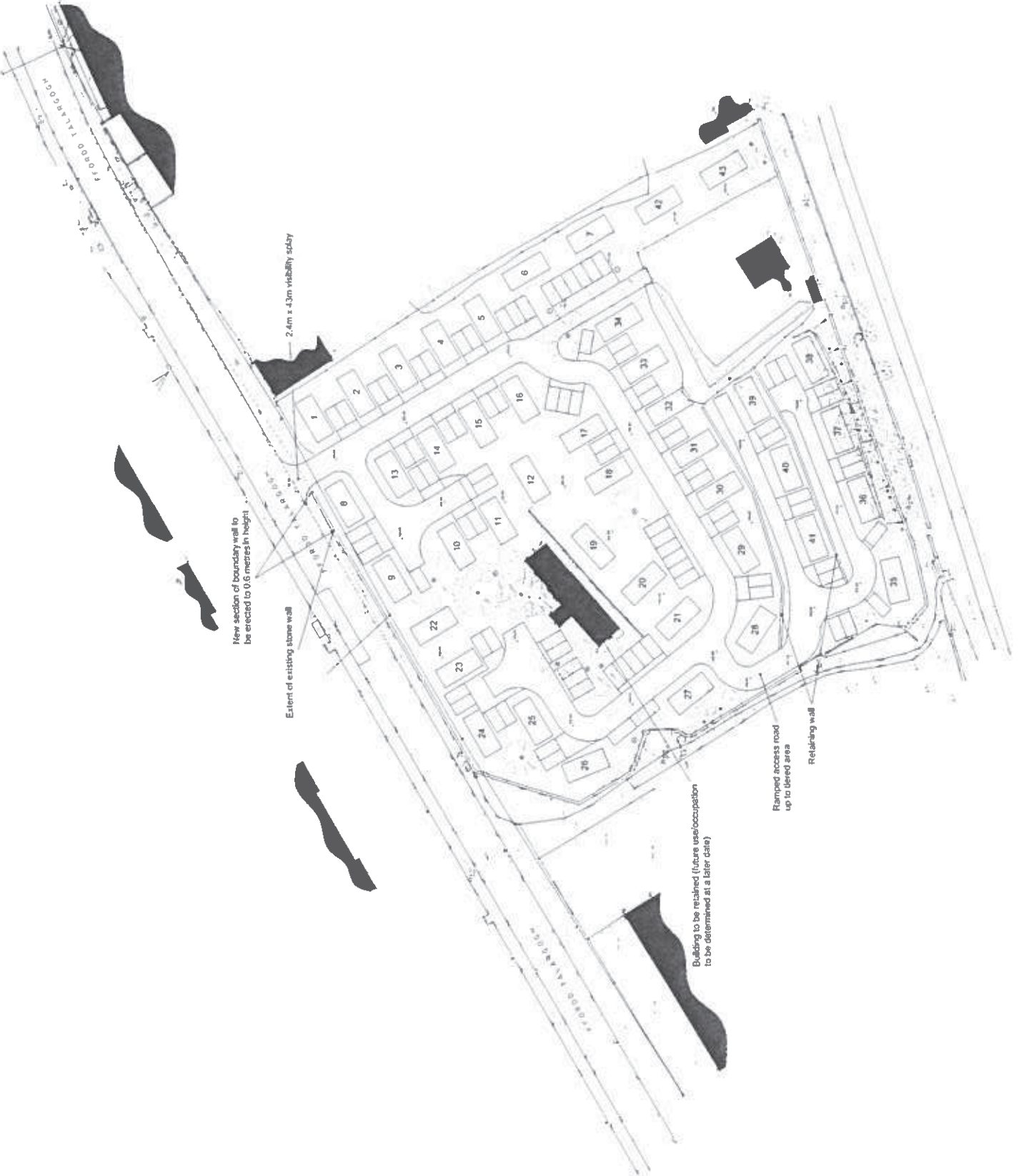

Tudalen 38

TYPICAL PARK HOME

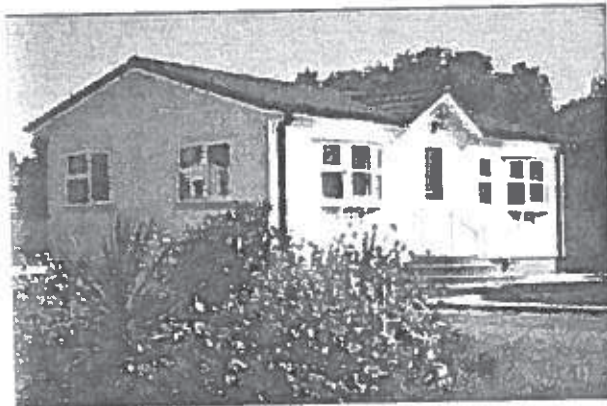
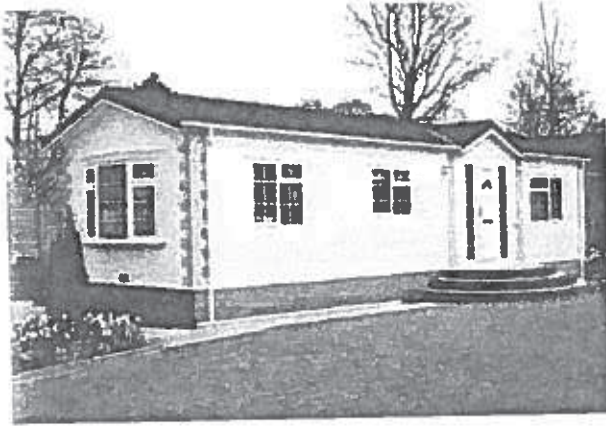

Drawing Title

Appendix 2 - Photographs of typical park homes

Project

Plas Deva Caravan Park, Fford Talargoch, Meliden, Prestatyn

Client

Flannigan Estates Limited

Planning Application	Dwn	Scale	Ckd	Date	Dwg No	Rev
	AK	NTS	CC	10 10 2013	FLA54/2-003	

Knights

1759

The Brampton, Newcastle-under-Lyme, Staffordshire, ST5 0QW
T 01782 619225 F 01782 712522 knightsllp.co.uk

ITEM NO: 2

WARD NO: Prestatyn Meliden

WARD MEMBER: Cllr Peter Evans

APPLICATION NO: 43/2013/1318/ PF

PROPOSAL: Change of use of land for the siting of up to 43 park homes for permanent residential occupation including access improvements and retention of existing building for site managers accommodation

LOCATION: Plas Deva Caravan Park Ffordd Talargoch Meliden Prestatyn

APPLICANT: MrW Flannigan Flannigan Estates Limited

CONSTRAINTS: Tree Preservation Order
Wildlife Site
PROW

PUBLICITY UNDERTAKEN: Site Notice – Yes
Press Notice – Yes
Neighbour letters - Yes

REASON(S) APPLICATION REPORTED TO COMMITTEE:
Scheme of Delegation Part 2

- Referral by Head of Planning / Development Control Manager

CONSULTATION RESPONSES:

PRESTATYN TOWN COUNCIL
Awaiting response

**CLWYDIAN RANGE AND DEE VALLEY AREA OF OUTSTANDING NATURAL BEAUTY
JOINT ADVISORY COMMITTEE**

“The JAC notes that this former caravan park which abuts the AONB boundary is allocated for housing in the LDP and, in this context, the committee has no objection in principle to development of the site for permanent residential use. The committee would prefer a more conventional housing development, but accepts that the site has an established prior use as a caravan park and that there may be a demand for low-cost park homes in the area.

However, whilst the principle of development is accepted the JAC is seriously concerned that the density of park homes proposed is excessive and will create an over developed appearance which will have a detrimental impact of the setting of the AONB. This is exacerbated by the need to remove a significant number of existing trees and shrubs, some of which are TPO protected, to facilitate such a high density. The proposed layout also appears regimented, lacking in visual interest and does not incorporate any open space or make provision for children’s play.

The JAC would therefore suggest that the proposals as submitted are unacceptable and would recommend a new approach to the design, layout and density of development on the site which will retain significant existing trees, ensure better separation of park homes to protect existing trees,

incorporates adequate open space and play provision, and includes a comprehensive landscaping scheme. Such a redesign will help soften the appearance of the development and better integrate it visually with the backdrop of Graig Fawr.

No details are provided of the proposed park home units, but the JAC would suggest that the colour of walls and roofs should be carefully controlled to ensure that the development presents a harmonious appearance which is in sympathy with its surroundings. In addition, if such permanent park homes enjoy residential permitted development rights these should be withdrawn by condition.

The intention to retain and extend the existing local stone frontage and boundary walls is supported.” (AONB Management Plan Policies PCP1 and PCP2)

NATURAL RESOURCES WALES

No objection

DWR CYMRU / WELSH WATER

No objection

DENBIGHSHIRE COUNTY COUNCIL CONSULTEES –

Head of Highways and Infrastructure

- Highways Officer

No objection subject to the inclusion of conditions requiring additional details to ensure the formation of a satisfactory access and visibility splays.

Pollution Control Officer

Expresses concerns relating to the detailed elements of the scheme which would need to be subject of a separate Site Licence, e.g. parking, drainage, water supply, refuse disposal, lighting

Tree Officer

Concerns raised to the original proposal to remove a number of trees which in turn would have a detrimental impact on the amenity of the area.

Ecologist

No objection subject to the inclusion of conditions requiring mitigation details for Common Lizards and an updated survey of plant species

Housing and Community Development Service

Has concerns relating to the principles of park homes in providing all year round housing accommodation

RESPONSE TO PUBLICITY:

Representations received from:-

Mr. J. Bowe, 6, Morfa Ddu Park, St. James Drive, Prestatyn

J. Huxley, 15, Morfa Ddu, St. James Drive, Prestatyn J. Blackshaw, 3, Morfa Ddu, St. James Drive, Prestatyn

Summary of planning based representations:

General comments from the owners of park homes on a site operated by the applicant on a nearby site in Prestatyn – outlining concerns regarding the management of the site. Also questions raised over potential flooding, drainage and lighting issues.

EXPIRY DATE OF APPLICATION: 30/1/2014

REASONS FOR DELAY IN DECISION:

- additional information required from applicant
- protracted negotiations resulting in amended plans
- re-consultations / further publicity necessary on amended plans and / or additional information

PLANNING ASSESSMENT:

1. THE PROPOSAL:

1.1 Summary of proposals

- 1.1.1 The application seeks full planning permission for the change of use of land at Plas Deva Caravan Park for the siting of up to 43 'park homes' for permanent residential occupation, including access improvements and retention of an existing building for site managers accommodation.
- 1.1.2 The application has been submitted with a layout plan indicating the siting of 43 park homes and the retention of the former caravan site managers dwelling for the same purpose, in connection with the proposed park home site.
- 1.1.3 The Design and Access Statement submitted sets out the legislative background of park homes explaining that the application seeks consent for the use of the land for park homes for permanent residential use and explains that the detailed layout of the site will be done in accordance with regulations set out within the Caravan Sites and Control of Development Act 1960 as the units are within the definition of caravans and will require a Site Licence.
- 1.1.4 The application documents state that the park homes would be marketed to retired and semi-retired persons over the age of 55 and that the site is designed and laid out to be low maintenance.
- 1.1.5 It is stated that the units proposed are different to traditional static or touring caravans but are in accordance with the Caravan Sites and Control of Development Act 1960 (as amended) and the structures would comply with section 13 (1) of the 1968 Act.
- 1.1.6 A tree constraints plan has been submitted showing all Category A and B trees to be retained. Category A trees are high quality trees with life expectancy of at least 40 years and Category B trees are moderate quality with life expectancy of at least 20 years.

1.2 Description of site and surroundings

- 1.2.1 Plas Deva is a vacant static and touring caravan site which is thought to have ceased operating in 2006 or 2007. This was prior to the submission of an outline application for residential development in 2007. The site contains all of the original concrete bases for the caravans and the site managers dwelling, known as 113 Ffordd Talargoch. The site is licenced for 65 caravans. It is relevant to note that the previous planning use and the licence allowed the site to be used for tourist use and not permanent residential occupation.
- 1.2.2 The site comprises of approximately 1ha of land and consists of a series of terraces sloping upwards to the rear of the site from Ffordd Talargoch.
- 1.2.3 The site has a number of trees which are protected by Preservation Orders located in a large group to the front of the site. An existing vehicular access to the site is to the north eastern corner . There is a secondary vehicular access off an existing track to the south western boundary which is now gated. Along Ffordd Talargoch the site is bounded by a

high stone wall.

1.2.4 The site shares its access with a private dwelling to the rear of the site (Gwrych Mount) which has a right of way leading through the site.

1.2.5 To the southern boundary the site abuts the Prestatyn to Dyserth walkway which lies at the base of Graig Fawr, which is a Site of Special Scientific Interest and within the Area of Outstanding Natural Beauty. Plans indicating the site location and accesses are attached to the front of the report.

1.3 Relevant planning constraints/considerations

1.3.1 The site is located within the development boundary of Meliden and is an allocated housing site within the Local Development Plan. This allocation reflects the planning permission which existed for residential development at the time of the adoption of the LDP. The site lies close to, but outside the boundary of the Area of Outstanding Natural Beauty and Graig Fawr Site of Special Scientific Interest.

1.4 Relevant planning history

1.4.1 Outline planning permission for residential development was granted in 2008, with an extension of time to submit reserved matters details for an additional 2 years agreed in 2011, which expired in October 2013. There are therefore no extant planning permissions in place for residential development.

1.5 Developments/changes since the original submission

1.5.1 The existing derelict building on the site is now shown to be retained for use as accommodation for a site manager in connection with the proposed park home site. All Category A and B trees within the site are now shown to be retained. Amendments to the access have been made with alterations proposed to the front boundary wall and visibility splays shown.

1.6 Other relevant background information

1.6.1 A 'Park Home' is defined as being a 'caravan' as set out in the Caravan Sites and Control of Development Act 1960 and 1968. A 'caravan' means any structure designed or adapted for human habitation which is capable of being moved from one place or another (whether by being towed, or by being transported on a motor vehicle or trailer) and any motor vehicle so designed or adopted.

1.6.2 Park Homes are constructed in two sections off site and then transported to the site where they are bolted together on a concrete base, fitted out and connected to mains services. Park Homes can vary in width and length depending on the type of unit that a prospective occupier purchases and sites on the land, however the dimensions are limited by the Caravan Sites and Control of Development Act 1960 to a maximum of 20m in length, 6.8m in width and 3.05m in height when measured internally from the floor at the lowest point to the ceiling at the highest level. An illustration of a typical Park Home is provided at the front of the report.

2. **DETAILS OF PLANNING HISTORY:**

2.1 43/2007/0714/PO Development of 1.0 ha of land for residential development and construction of new vehicular access (outline application) GRANTED at Planning Committee 3rd September 2008.

43/2011/0798/PS Variation of condition no's 2 and 3 of outline planning permission code no. 43/2007/0714 to extend the period for submission of reserved matters and commencement of development APPROVED under delegated powers 11th October 2011 with the following conditions imposed:

*Application for approval of reserved matters shall be made to the Local Planning Authority before the expiration of **two years** from the date of this permission.*

The development hereby permitted shall be begun either before the expiration of five years from the date of this permission, or before the expiration of two years from the date of approval of the last of the reserved matters to be approved, whichever is the later.

3. RELEVANT POLICIES AND GUIDANCE:

The main planning policies and guidance are considered to be:

Denbighshire Local Development Plan (adopted 4th June 2013)

Policy RD1 – Sustainable development and good standard design

Policy BSC 1 – Growth Strategy for Denbighshire

Policy BSC 3 – Securing Infrastructure Contributions from Development

Policy BSC 11 – Recreation and Open Space

Policy BSC4 – Affordable Housing

Policy PSE12 – Chalet, static and touring caravan and camping sites

Policy VOE2 – Area of Outstanding Natural Beauty and Area of Outstanding Beauty

Policy VOE5 – Conservation of natural resources

Policy ASA3 – Parking standards

3.1 Supplementary Planning Guidance

3.2 Supplementary Planning Guidance 7: Residential Space Standards

Supplementary Planning Guidance 20: Static Caravan and Chalet Development

Supplementary Planning Guidance 21: Parking Standards

Supplementary Planning Guidance 25: Residential Development Design Guide

3.3 Government Policy / Guidance

Planning Policy Wales Edition 6 February 2014

4. MAIN PLANNING CONSIDERATIONS:

In terms of general guidance on matters relevant to the consideration of a planning application, Planning Policy Wales Edition 6, February 2014 (PPW) confirms the requirement that planning applications 'should be determined in accordance with the approved or adopted development plan for the area, unless material considerations indicate otherwise' (Section 3.1.2). PPW advises that material considerations must be relevant to the regulation of the development and use of land in the public interest, and fairly and reasonably relate to the development concerned., and that these can include the number, size, layout, design and appearance of buildings, the means of access, landscaping, service availability and the impact on the neighbourhood and on the environment (Sections 3.1.3 and 3.1.4).

The following paragraphs in Section 4 of the report therefore refer to the policies of the Denbighshire Local Development Plan, and to the material planning considerations which are considered to be of relevance to the proposal.

4.1 The main land use planning issues in relation to the application are considered to be:

4.1.1 Principle

4.1.2 Visual amenity

4.1.3 Residential amenity

4.1.4 Ecology

4.1.5 Highways (including access and parking)

4.2 In relation to the main planning considerations:

4.2.1 Principle

The assessment of this application has been difficult as it raises key issues of principle that cross over between caravan and housing policies, but also involves Site Licencing considerations which fall within the remit of the Public Protection Section.

In terms of the policy context: -

The main policy in the LDP which is relevant to the principle of housing development in towns and villages is Policy BSC1, which seeks to make provision for new housing in a range of locations, concentrating development within identified development boundaries.

Policy RD1 states that development proposals within development boundaries will be supported subject to compliance with detailed criteria.

Policy BSC3 of the local development plan sets the basic requirement for development to contribute where relevant to the provision of infrastructure including affordable housing, in line with Policy BSC4. Policy BSC4 relates specifically to affordable housing, and requires that all developments of three or more residential units provide a minimum of 10% affordable housing either on site on developments of 10 or more units, or by way of a financial contribution on developments of less than 10 units.

Policy BSC 11 requires new developments to provide open space in accordance with the County's minimum standard of 2.4 hectares per 1000 population. It states that open space should always be provided on site, and that commuted sums will only be acceptable where it is demonstrated that development would not be financially viable should the full requirement be provided on site, or where it is impractical to provide the full requirement onsite. Where there is no identified shortfall of open space in an area, the option of a commuted sum payment may be appropriate to mitigate impact on existing open space and equipment.

Chapter 9 (para 9.2.20) in Planning Policy Wales states that residential mobile homes can make a contribution to overall housing provision and have a part to play in providing low cost accommodation for small households.

Policy PSE 12 of the LDP covers chalet, static and touring caravan and camping sites. Given the authorised previous use of this site this Policy would be relevant to this case. The Policy is generally supportive of proposals involving environmental improvements of existing holiday sites by their remodelling, provision of new facilities and by landscaping provided the development is acceptable in terms of other Local Development Plan policies. The policy does not allow the change of use of a static caravan or chalet site from tourist use to residential use which is particularly relevant to the application.

In relation to the County's growth strategy, Policy BSC 1 sets out the housing contributions expected from new and existing commitments and the table of sizes suggests Plas Deva has the potential to provide 30 dwellings. Policy BSC 1 expects housing sites to provide a range of house sizes, types and tenures to reflect local need and demand with the associated affordable housing and open space provision/contributions.

This application seeks permission to change the use of a former holiday caravan site to a park home site, with units used for permanent residential occupancy.

In relation to the policies listed above, Officers interpretation is as follows:-

Housing is one of the key factors that influence people's health and well-being. Providing

opportunities for the right scale and mix of housing to meet the needs of a growing population including provision of safe and affordable housing are key considerations of the Local Development Plan. Policy BSC 1 anticipates that the application site would deliver 30 dwellings of mixed sizes, types and tenure providing affordable housing and open space in accordance with adopted policies. On a site in this location, on a main route through the village of Meliden adjacent to the AONB a high quality housing development would be expected which respects the nature and constraints of the site and provide a good quality living environment for future residents. Respectfully, it is not considered Park Home development is what was envisaged for the County's allocated housing sites, as it would not provide mixed sizes, types and tenure of properties or provide affordable housing or open space. The detailed layout of park homes for permanent residential occupancy is controlled by Model Caravan Standards and not planning policy guidance, and therefore it is not considered that the proposal would deliver the quality of development required by Policy BSC 1. There is also a potential concern here for the precedent this proposal would set for similar developments on other allocated housing sites.

In relation to Policy BSC 4, whilst the proposed park homes may contribute to housing supply there is no evidence submitted that they would provide affordable housing. Concerns have been raised by the Council's Housing Section with regards the proposal. It is acknowledged that there is a need for smaller accommodation in Denbighshire and as the site is in close proximity to Prestatyn which is a seaside town, there will be a higher percentage of older people. However the park homes proposed would not meet the identified needs as in the main they require subsidised or specialised accommodation. Housing Officers have suggested that the park homes proposed would not meet any affordable accommodation targets in Denbighshire or help towards meeting any identified social or assisted housing need. It should also be noted that the housing demand in the area for 2, 3 and 4 bed houses is high

Policy BSC 11 requires new developments to provide open space in accordance with the County's minimum standard of 2.4 hectares per 1000 population. The application proposes no on-site open space. It has been suggested within the submission that the park homes site would contain incidental open space with many trees present which would be maintained by the site operator and as the site is located within close walking distance of publicly accessible amenity space as well as adjacent footpath links the proposal complies with Policy BSC 11. Also as the site would be marketed to retired and semi-retired persons over the age of 55, no children's play space is proposed on-site.

Policy PSE 12 clearly states that the change of use of tourist sites to residential use will not be permitted. Whilst it is recognised in Planning Policy Wales (Section 9.2.20) that park homes can make a contribution to overall housing provision and have a part to play in providing low cost accommodation for small households, the proposal is considered to be contrary to the local development plan policy which restricts the use of caravan sites for permanent residential use.

Concerns have been raised by the Council's Environmental Health Officers with regards the principle of park home development, and detailed elements of the scheme

Significantly, the site is shown as a housing allocation within the Local Development Plan. The plan seeks to secure housing developments which provide a range of house sizes, types and tenures providing open space and affordable housing provision. The proposal is to locate 43 small Park homes with no open space or affordable housing provision offered. In Officer's opinion the proposal would not meet the objectives of the plan and whilst park homes may contribute to housing supply it is not considered that they offer the mix and nature of development the Council should be encouraging on sites allocated for

housing in its Local Development Plan.

4.2.2 Visual amenity

Local Development Plan Policy RD 1 test (i) requires due regard to issues of siting, layout, form, character, design, materials, aspect, microclimate and intensity of use of land / buildings and spaces between buildings, which are matters relevant to the visual impact of development; test (vi) requires that development does not unacceptably affect prominent public views into, out of, or across any settlement or area of open countryside; test (vi) requires the incorporation of existing landscape or other features, takes account of site contours, and changes in levels and prominent skylines; and test (xiii) requires the incorporation of suitable landscaping measures to protect and enhance development in its local context.

The site lies in a prominent location off the main road through the village of Meliden, consisting of a sloping site with terraces to the rear and a number of mature trees. The proposal is to retain the existing dwelling at 113 Ffordd Talargoch and all category A and B trees.

The density of the layout is high(39 unit/hectare), as the layout has been designed having regard to the Model Caravan Standards and the existing use of the site as a holiday caravan site for 65 units. The units themselves are single storey structures which would have limited visual impact on the area. Overall, it is considered that the proposal by virtue of the scale, design and existing screening provided by mature vegetation would not have a negative visual impact on the area. It is therefore considered acceptable in relation to the policies and guidance listed above.

4.2.3 Residential amenity

Local Development Plan Policy RD 1 test (i) requires due regard to issues of siting, layout, form, character, design, materials, aspect, microclimate and intensity of use of land / buildings and spaces between buildings, which touch on the potential for impact on residential amenity; test (vi) sets the requirement to assess the impact of development on the amenities of local residents, other land and property users, or characteristics of the locality, in terms of increased activity, disturbance, noise, dust, fumes, litter, drainage, light pollution, etc.

There is a dwelling sited to the rear of the site and access to this is shown to be maintained as existing. This property is sited at the highest part of the site. Also to the north eastern boundary is the site of the former Meliden Garden Centre, which has full planning permission for 8 no. dwellings, therefore there are amenity issues to be taken in to account. In relation to spacing and amenity standards the submission refers to the Model Caravan Standards which have to be adhered to in order to secure a site licence. It is understood that if the proposals do not comply with the relevant standards, then the numbers/layout may change and there are controls to ensure that adequate fencing/screening is in place to protect amenities of residents.

If the application is looked at in relation to caravan legislation there would be a requirement to meet basic standards relating to protection of residential amenity, these are not the same standards that would be applied to a normal housing development.

If the application is looked at in relation to normal development control policies including Policy RD 1 relating to housing development, there would be a requirement for provision of private garden areas, adequate separation distances between dwellings, car parking, landscaping etc. The submitted layout does not demonstrate that the normal standards for housing development can be met.

Having regard to the above it is not considered that the proposal would have a negative impact on the residential amenity of existing properties close to the application site. There are however questions over the levels of privacy etc which can be achieved for future occupiers of the units which is a negative factor in the consideration of this application.

4.2.4 Ecology

Local Development Plan Policy RD 1 test (iii) requires development to protect and where possible to enhance the local natural and historic environment. Policy VOE 5 requires due assessment of potential impacts on protected species or designated sites of nature conservation, including mitigation proposals, and suggests that permission should not be granted where proposals are likely to cause significant harm to such interests. This reflects policy and guidance in Planning Policy Wales (Section 5.2), current legislation and SPG 18 – Nature Conservation and Species Protection, which stress the importance of the planning system in meeting biodiversity objectives through promoting approaches to development which create new opportunities to enhance biodiversity, prevent biodiversity losses, or compensate for losses where damage is unavoidable.

A protected species survey has been submitted and the Biodiversity Officer has raised no objection subject to the recommendations being followed, along with the requirement to submit an updated plant species report and mitigation details for the common lizard.

The proposal is therefore considered acceptable in relation to impact on ecology subject to conditions.

4.2.5 Highways (including access and parking)

Local Development Plan Policy RD 1 tests (vii) and (viii) oblige provision of safe and convenient access for a range of users, together with adequate parking, services and manoeuvring space; and consideration of the impact of development on the local highway network. Policy ASA 3 requires adequate parking spaces for cars and bicycles in connection with development proposals, and outlines considerations to be given to factors relevant to the application of standards. These policies reflect general principles set out in Planning Policy Wales (Section 8) and TAN 18 – Transport, in support of sustainable development.

The proposal is to alter the existing access by repositioning and widening and also to lower the existing stone boundary wall in part to improve visibility. Within the site the road layout will be upgraded to serve the proposed park homes and parking facilities for each park home would be provided. Standards relating to the internal road layout, parking, footpaths and pavements are set out in the Model Caravan Standards.

The Head of Highways has raised no objection to the proposal subject to the inclusion of conditions to ensure the formation of a safe and satisfactory access with adequate visibility splays.

The proposal is therefore considered acceptable in relation to impact on highway safety subject to conditions.

4.2.6 Trees

Local Development Plan Policy RD 1 test (xiii) obliges developments to incorporate suitable landscaping measures which should create a visually pleasant, sustainable and biodiversity rich environment that protects and enhances existing landscape features and also creates new features and areas of open space that reflect local character and sense of place.

The site contains a number of trees, with a number of trees located to the front of the site

covered by a protection order.

The applicant has amended the proposal to ensure that all Category A and B trees which are high and moderate quality trees are retained. These trees have a high amenity value within the area and their retention is supported.

4.2.7 Other Matters

There is reference in representations to the management of another Park Homes Site nearby, Officers view is that this is not materials to the consideration of this proposal.

In relation to the retention of the existing building for site managers accommodation, no detail has been provided with the submission and in the event that planning permission is granted a condition should be imposed to ensure the building remains tied to the park home site along with details of the restoration of the building.

5. SUMMARY AND CONCLUSIONS:

5.1 It is considered that the principle of the proposal is unacceptable and contrary to Policy PSE 12 in the adopted Local Development Plan.

5.2 The site is shown as a housing allocation within the Local Development Plan and seeks to secure housing developments which provide a range of house sizes, types and tenures providing open space and affordable housing provision. In Officer's opinion the proposal would not meet the objectives of the plan and whilst park homes may contribute to housing supply it is not considered that they offer the mix and nature of development the Council should be encouraging on sites allocated for housing in its Local Development Plan.

RECOMMENDATION: REFUSE - for the following reasons:

1. It is the opinion of the Local Planning Authority that the proposal to change the use of an existing holiday caravan site to permanent residential use is unacceptable in principle, being contrary to Policy PSE 12 in the Denbighshire Local Development Plan which seeks to secure improvements to existing holiday accommodation.

2. It is the opinion of the Local Planning Authority that the proposal is contrary to Policy BSC 1 of the Denbighshire Local Development Plan and the overall strategy in relation to housing development which seeks to provide a range of house sizes, types and tenure in connection with new development. The proposal to site up to 43 park homes on an allocated housing site would not provide the mix and nature of development the Council is looking to encourage on sites allocated for housing in its Local Development Plan also contrary to Policy RD 1 in the Denbighshire Local Development Plan which relates to sustainable development and good standard design.

NOTES TO APPLICANT:

None

Mae tudalen hwn yn fwriadol wag

Heading:

REFERENCE NO. 43/2014/0013/PF
PRESTATYN FOOTBALL CLUB
BASTION GARDENS, PRESTATYN

Graham Boase
Head of Planning & Public Protection
Denbighshire County Council
Caledfryn
Smithfield Road
Denbigh
Denbighshire LL16 3RJ
Tel: 01824 706800 Fax: 01824 706709

 Application Site



Date 3/6/2014
Centre = 306362 E 383549 N

Scale 1/2500

This plan is intended solely to give an indication of the LOCATION of the application site which forms the subject of the accompanying report. It does not form any part of the application documents, and should not be taken as representative of the proposals to be considered, which are available for inspection prior to the meeting.

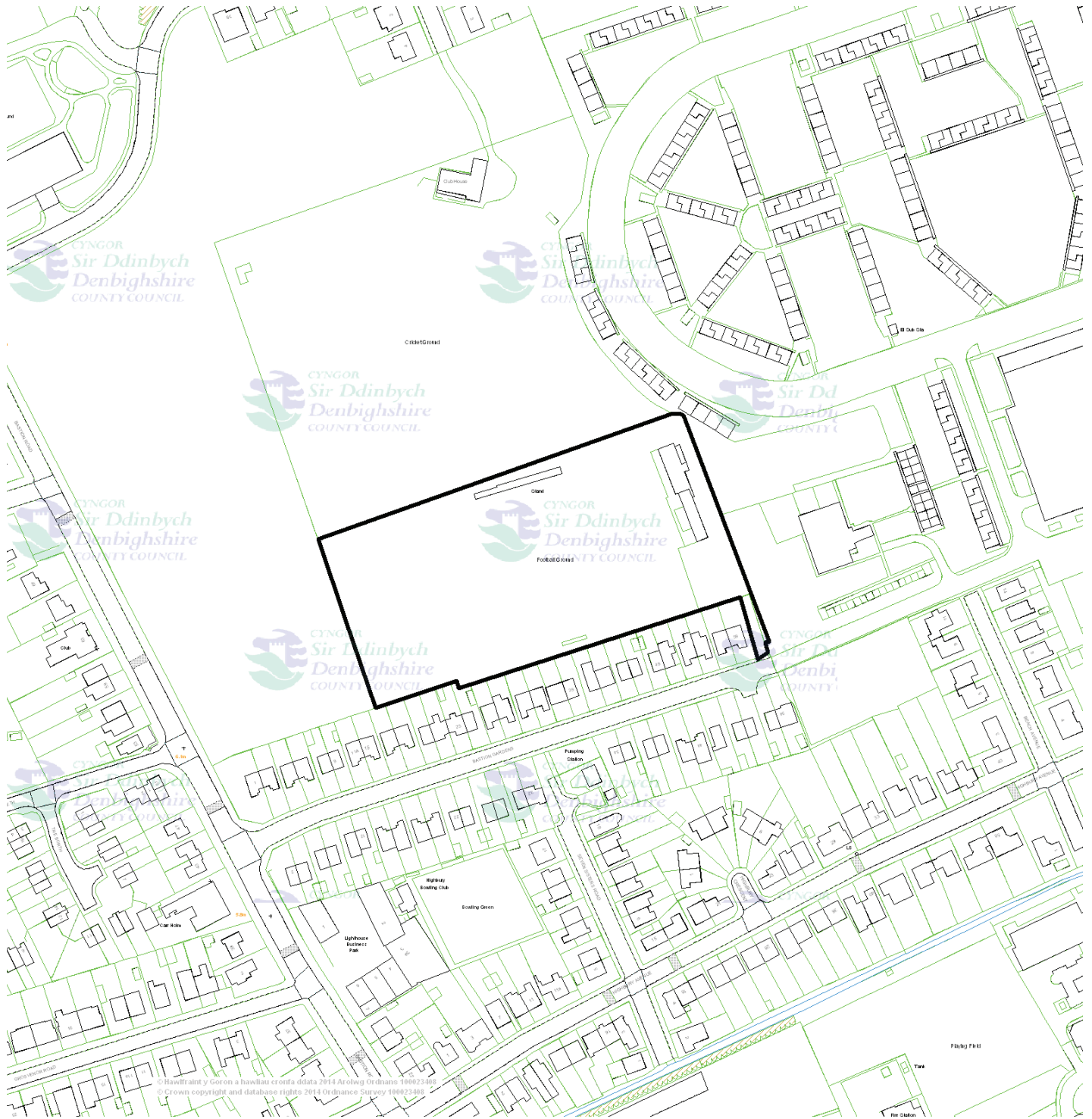

This map is reproduced from Ordnance Survey material with the permission of Ordnance Survey on behalf of the Controller of Her Majesty's Stationery Office. © Crown copyright. Unauthorized reproduction infringes Crown copyright and may lead to prosecution or civil proceedings. Denbighshire County Council. 100023408. 2011.

Atgynhychir y map hwn o ddeunydd yr Ordnance Survey gyda chaniatâd yr Ordnance Survey ar ran Rheolwr Llyfrfa Ei Mawrhydi © Hawffraint y Goron. Mae atgynhychu heb ganiatâd yn torri hawffraint y Goron a gall hyn arwain at erlyniad neu achos sifil. Cyngor Sir Ddinbych. 100023408. 2011.

SITE PLAN

As shown above

● FLOODLIGHTS

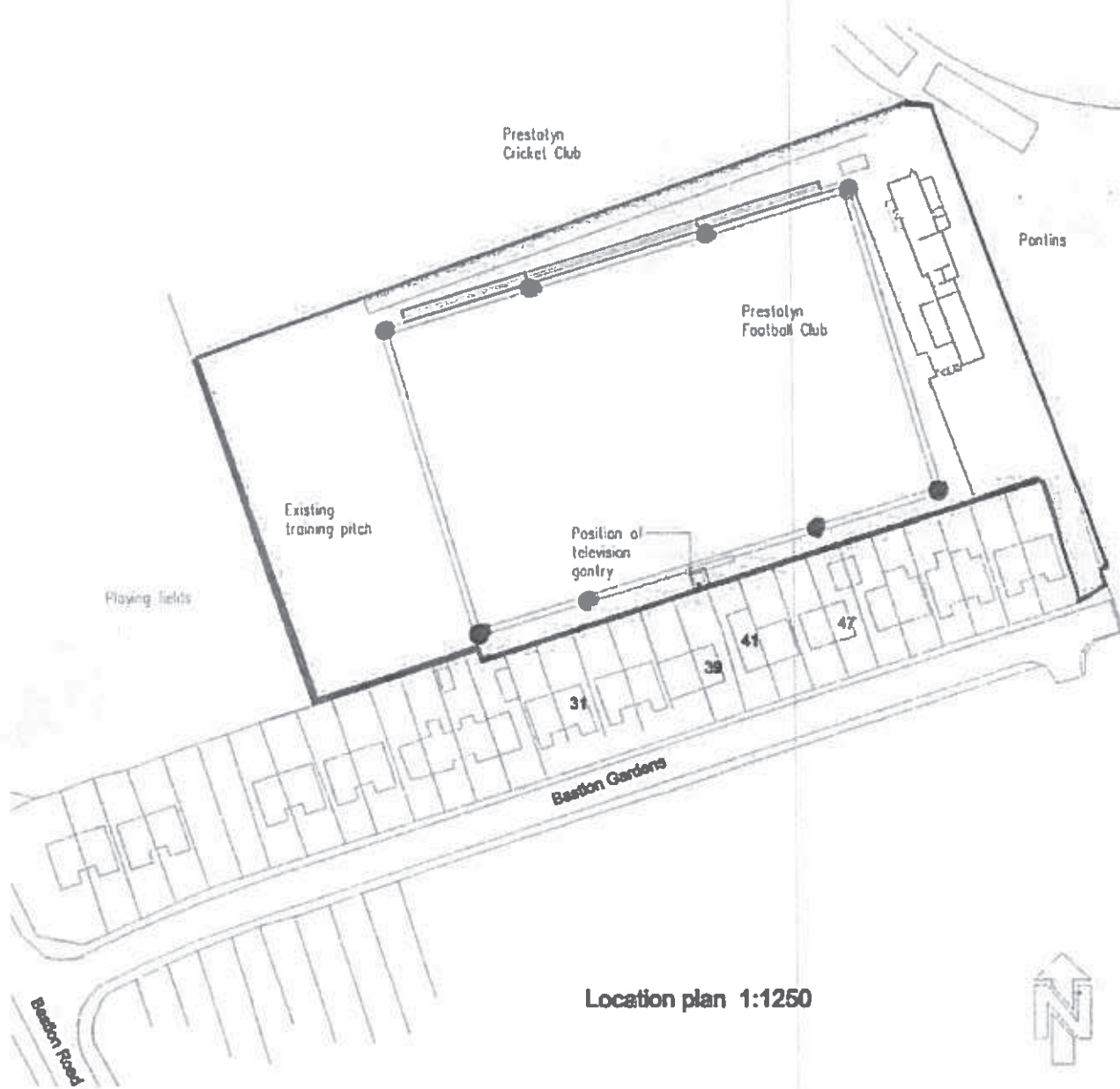

Location plan 1:1250

PRESTATYN FOOTBALL CLUB
Bastion Gardens
Prestatyn.

SCALE 1:1250 @ A4
DATE November 2008
LAWRENCE PARRY ASSOCIATES
HILL HOUSE, HILLSIDE, PRESTATYN,
01745 854945

DRWG. No 3688/01



ITEM NO: 3

WARD NO: Prestatyn East

WARD MEMBER(S): Cllr James Davies and Cllr Julian Thompson Hill

APPLICATION NO: 43/2014/0013/ PS

PROPOSAL: Variation of condition no. 2 of planning permission code no. 43/2008/0072 to permit the use of the floodlights between 1430hrs and 2200hrs on no more than 3 days in any 7 day period

LOCATION: Prestatyn Football Club Bastion Gardens Prestatyn

APPLICANT: MrGareth Owens

CONSTRAINTS: None

PUBLICITY UNDERTAKEN: Site Notice – No
Press Notice – No
Neighbour letters - Yes

REASON(S) APPLICATION REPORTED TO COMMITTEE:
Scheme of Delegation Part 2

- Recommendation to grant / approve – 4 or more objections received
- Recommendation to grant / approve – Town / Community Council objection
- Member request for referral to Committee

CONSULTATION RESPONSES:

PRESTATYN TOWN COUNCIL:

“Defer - Ward Councillors reported they were aware of residents objections arising from the significant proposed increase in times and activity. Committee requested clarification on reasons for proposed increase.”

DENBIGHSHIRE COUNTY COUNCIL CONSULTEES –
Pollution Control Officer:

- The lighting issue should be controlled through condition using the Institution of Lighting Professionals Guidance Notes for the Reduction of Obtrusive Light GN01:2011. The Environmental Zone is classed as E3 and the relevant Light Intrusion (into windows) should therefore be limited to 10lux as the times of operation are pre-curfew. The actual lighting levels are to be assessed by an independent lighting engineer in order to confirm that the limits are being complied with.
- Although there will be some increase in the use of the pitches as a result of the lighting, this is viewed as not too excessive. The use of the lighting is to be controlled to no more than 3 days in any 7 day period and this will provide protection of amenity for the nearby residents.
- The lights will be turned off at 22:00hrs and this includes the time taken for the tidy up after the match period and so as a result the actual noisier events will be finished before this time (likely to be about 21:30hrs).

RESPONSE TO PUBLICITY:

In objection

Representations received from:

Mr & Mrs J & C Cook, 55 Bastion Gardens, Prestatyn

S. Tuey, 32, Bastion Gardens, Prestatyn

Mrs. S. Woodward, 57, Bastion Road, Prestatyn

B. Paterson, 120 Ffordd Ty Newydd

G. Roberts, 41, Bastion Gardens, Prestatyn

Mrs M Wadsworth, 28 Bastion Gardens, Prestatyn

Mrs S Ahmad, 33 Bastion Gardens, Prestatyn

Mrs P A Higson, 40 Bastion Gardens, Prestatyn

Mrs S Beattie, 39 Bastion Gardens, Prestatyn (Petition with 27 signatures)

C A Holliday 54 Bastion Gardens Prestatyn

P & A Kerfoot 35 Bastion Gardens Prestatyn

Mr J Thompson 46 Bastion Gardens Prestatyn

Ms A Clare 46 Bastion Gardens Prestatyn

Mrs. S. Ahmad, 33, Bastion Gardens, Prestatyn

Mrs. M. Wadsworth, 28 Bastion Gardens, Prestatyn

Miss S. Tuey, 32 Bastion Gardens, Prestatyn

Summary of planning based representations in objection:

Residential amenity:

Residents are concerned that the proposal would have a detrimental impact upon residential amenity by way of light spillage, additional noise arising from additional activity, and road congestion.

EXPIRY DATE OF APPLICATION:

REASONS FOR DELAY IN DECISION (where applicable):

- timing of receipt of representations
- delay in receipt of key consultation response(s)
- additional information required from applicant
- protracted negotiations resulting in amended plans
- re-consultations / further publicity necessary on amended plans and / or additional information
- awaiting consideration by Committee

PLANNING ASSESSMENT:

1. THE PROPOSAL:

1.1 Summary of proposals

1.1.1 Permission is sought for the variation of planning condition 2 of planning permission code no. 43/2008/0072 to permit the use of floodlights at Prestatyn Town Football Club between 14:30hrs and 22:00hrs on no more than 3 days in any 7 day period. The proposal relates to the 8 existing 15m high floodlights.

1.1.2 The original condition on the 2008 permission restricted the use of floodlights to 16:45 hours (i.e. 4.45pm) once in any 14 day period, with the provision of a maximum number of 12 days in any 12 month period where the use is permitted to 21:15 hours (9.15pm).

1.1.3 The application is made on the basis that the club's requirements have changed since 2008. The club is now in the Welsh Premier League which requires clubs to play evening matches on a weekly/fortnightly basis (fixtures list dependent and at the discretion of the Football Association of Wales). It is understood that the evening games frequently finish after 21:15 hrs. It is further understood that within some 7 day

periods the club is required to play two evening games and hold one training session. During the winter months use of floodlights is therefore required.

- 1.1.4 The club has stated that it can no longer comply with the original condition for reasons beyond their control (i.e. they cannot dictate when matches are held). For this reason the club has applied to vary the original planning condition to allow them to use floodlights more frequently, and to a time which would allow them to finish an evening match without being in breach of a planning condition.

1.2 Description of site and surroundings

- 1.2.1 Prestatyn Football Club is located on land to the east of Bastion Road to the south of the Cricket Ground. The grounds are accessed off Bastion Gardens a residential cul de sac.

- 1.2.2 The Football Club have occupied the site since the 1970's. The site comprises of a parking area on the east side, clubhouse and changing rooms, the football pitch and a smaller training pitch on the western side.

1.3 Relevant planning constraints/considerations

- 1.3.1 The site is within the Prestatyn development boundary as drafted in the proposals map of the Local Development Plan.

1.4 Relevant planning history

- 1.4.1 The floodlights were originally granted planning permission in 2008 and as detailed above, the hours of use were limited in the interest of residential amenity.

1.5 Developments/changes since the original submission

- 1.5.1 The application was originally submitted as a variation to allow the use of floodlights for a 'minimum' of 3 days per week. This has been amended to provide greater clarity as to how frequently and for how long the floodlights would be used.

2. **DETAILS OF PLANNING HISTORY:**

- 2.1 43/2008/0072 - Extension to and regularisation of stands, clubhouse and store, erection of floodlights and associated works. GRANTED by Planning Committee 10 April 2008

3. **RELEVANT POLICIES AND GUIDANCE:**

The main planning policies and guidance are considered to be:
Denbighshire Local Development Plan (adopted 4th June 2013)
Policy RD1 – Sustainable development and good standard design
Policy BSC11 – Recreation and Open Space

- 3.1 Supplementary Planning Guidance
None

3.2 Government Policy / Guidance

Planning Policy Wales Edition 6 February 2014
Planning Guidance (Wales) – TAN 16 – Sport and Recreation

3.3 Other material considerations

Institute of Lighting Engineers: Guidance Notes for the Reduction of Obtrusive Light
GN01:2011

4. **MAIN PLANNING CONSIDERATIONS:**

In terms of general guidance on matters relevant to the consideration of a planning application, Planning Policy Wales Edition 6, February 2014 (PPW) confirms the requirement that planning applications 'should be determined in accordance with the approved or adopted development plan for the area, unless material considerations indicate otherwise' (Section 3.1.2). PPW advises that

material considerations must be relevant to the regulation of the development and use of land in the public interest, and fairly and reasonably relate to the development concerned., and that these can include the number, size, layout, design and appearance of buildings, the means of access, landscaping, service availability and the impact on the neighbourhood and on the environment (Sections 3.1.3 and 3.1.4).

The following paragraphs in Section 4 of the report therefore refer to the policies of the Denbighshire Local Development Plan, and to the material planning considerations which are considered to be of relevance to the proposal.

4.1 The main land use planning issues in relation to the application are considered to be:

- 4.1.1 Principle
- 4.1.2 Residential amenity

4.2 In relation to the main planning considerations:

- 4.2.1 Principle

The application site lies within the settlement limits of Prestatyn as defined in the Local Development Plan on a site protected by Policy BSC11 of the LDP. The proposed variation would not conflict with this policy in that it would not result in the loss of a recreational asset. Policy RD1, Planning Policy Wales and TAN16 recognise that development, including new/improved recreation facilities, need to be considered against amenity impacts, including where the principle is acceptable. Therefore the proposal is considered acceptable in principle, subject to an assessment of the impacts.

- 4.2.2 Residential amenity

Local Development Plan Policy RD 1 test (i) requires due regard to issues of siting, layout, form, character, design, materials, aspect, microclimate and intensity of use of land / buildings and spaces between buildings, which touch on the potential for impact on residential amenity; test (vi) sets the requirement to assess the impact of development on the amenities of local residents, other land and property users, or characteristics of the locality, in terms of increased activity, disturbance, noise, dust, fumes, litter, drainage, light pollution, etc..

A number of objections have been received on the basis that the proposed variation would result in harm to residential amenity. Some of these objections are made on the basis of additional disturbance and noise by way of additional activity. Other objections are made on the basis that the light spillage into the neighbouring gardens/houses from the floodlights would be unacceptable on a more frequent and longer basis than the 2008 permission permits.

In acknowledging the basis of local concerns, and with regard to the perception that the proposal would result in additional activity at the ground, it is Officers opinion that the likely intensification of use would be limited. The number of fixtures at the ground is likely to remain similar to previous seasons, and it is understood that training has historically taken place at the site, albeit on a smaller floodlit pitch. It is to be noted during the summer months the ground can be used late into the evening without the need for floodlighting and outside any planning control. The Local Planning Authority does not have control over the frequency of use of the pitch as this has established itself gradually over the last 3 decades. However, it is acknowledged that the use of floodlights does to an extent inadvertently formalise the intensity of use. It is Officers' opinion that given the history of the site and the nature of the use, the hours proposed per 7 day period are unlikely to result in a material harm to the amenity of residents over and above what is already permitted.

Notwithstanding the above, Members are advised that as the proposal relates specifically to the use of floodlights at the site, a key consideration is the impact of the

lights on the amenity of the dwellings and whether 22:00 is unreasonably late to permit their use, and whether 3 times in any 7 day period is too frequent.

To assist consideration of the issue, there is useful technical advice from The Institute of Lighting Engineers (ILE), who have published guidance notes for the reduction of obstructive light. The 2011 document offers advisory maximum light levels for sensitive facades (neighbouring windows for example) - referred to as Light Intrusion Levels. In a suburban/edge of town centre location such as this site, it is recommended that the lighting level, when measured flat on the glazing at the centre of a window should not exceed 10 lux (*Table 2: Institute of Lighting Engineers: Guidance Notes for the Reduction of Obtrusive Light GN01:2011*). It is considered that the light levels at neighbouring windows can be satisfactorily controlled through a suitably worded planning condition.

On the understanding that the light levels at sensitive facades can be adequately controlled to operate within the ILE tolerances, it is considered that to allow the use of floodlights 3 times within any 7 day period until 22:00hrs, would not be unreasonable or result in an unacceptable impact on residential amenity. The proposal would comply with planning policy RD1 in this respect, along with guidance relating to the reduction of obtrusive light.

5. SUMMARY AND CONCLUSIONS:

- 5.1 In Officers' opinion, and in respecting local concerns, subject to the imposition of suitable conditions controlling the light levels at sensitive facades it is not considered that the proposals would result in an unreasonable impact on residential amenity for the occupants of neighbouring dwellings.

RECOMMENDATION: GRANT - subject to the following conditions:-

Condition 2 shall be worded as follows:

2. The floodlighting hereby permitted shall be subject to compliance with the following restrictions;

- a) the hours of use shall be restricted to between 14:30 - 22:00 hours for a maximum of three times in any 7 day period;
- b) a register identifying all users and hours of use of the floodlighting shall be kept and made available for inspection by Officers of the Local Planning Authority on request.
- c) The vertical illuminance at any affected facade shall be controlled to a maximum of 10 Lux at all times, and all external lighting shall comply with the recommendations of the Institution of Lighting Engineers "Guidance Notes for the Reduction of Light Pollution".

Reason for the condition

In the interest of residential amenity.

And shall be subject to the following additional condition

7. The floodlights shall not be permitted to operate until 22:00 hours on any occasion until there has been carried out, at Prestatyn Town Football Clubs expense, a suitable technical survey by an independent lighting engineer to demonstrate that the lighting levels specified in condition 2(c) can be met, such survey has been submitted to the Local Planning Authority and the written consent has been obtained from the Local Planning Authority that the lights may be operated in accord with the variation sought.

Reason for the condition:

in the interest of residential amenity

NOTES TO APPLICANT:

You are advised that all other conditions on planning permission 43/2008/0072 still apply to the use

Mae tudalen hwn yn fwriadol wag

Heading:

REFERENCE NO. 31/2014/0432/PF
LAND SOUTH OF ST ASAPH
BUSINESS PARK, ST ASAPH

Graham Boase
Head of Planning & Public Protection
Denbighshire County Council
Caledfryn
Smithfield Road
Denbigh
Denbighshire LL16 3RJ

Tel: 01824 706800 Fax: 01824 706709

 Application Site



Date 2/6/2014

Scale 1/5000

Centre = 302065 E 373721 N

This plan is intended solely to give an indication of the LOCATION of the application site which forms the subject of the accompanying report. It does not form any part of the application documents, and should not be taken as representative of the proposals to be considered, which are available for inspection prior to the meeting.

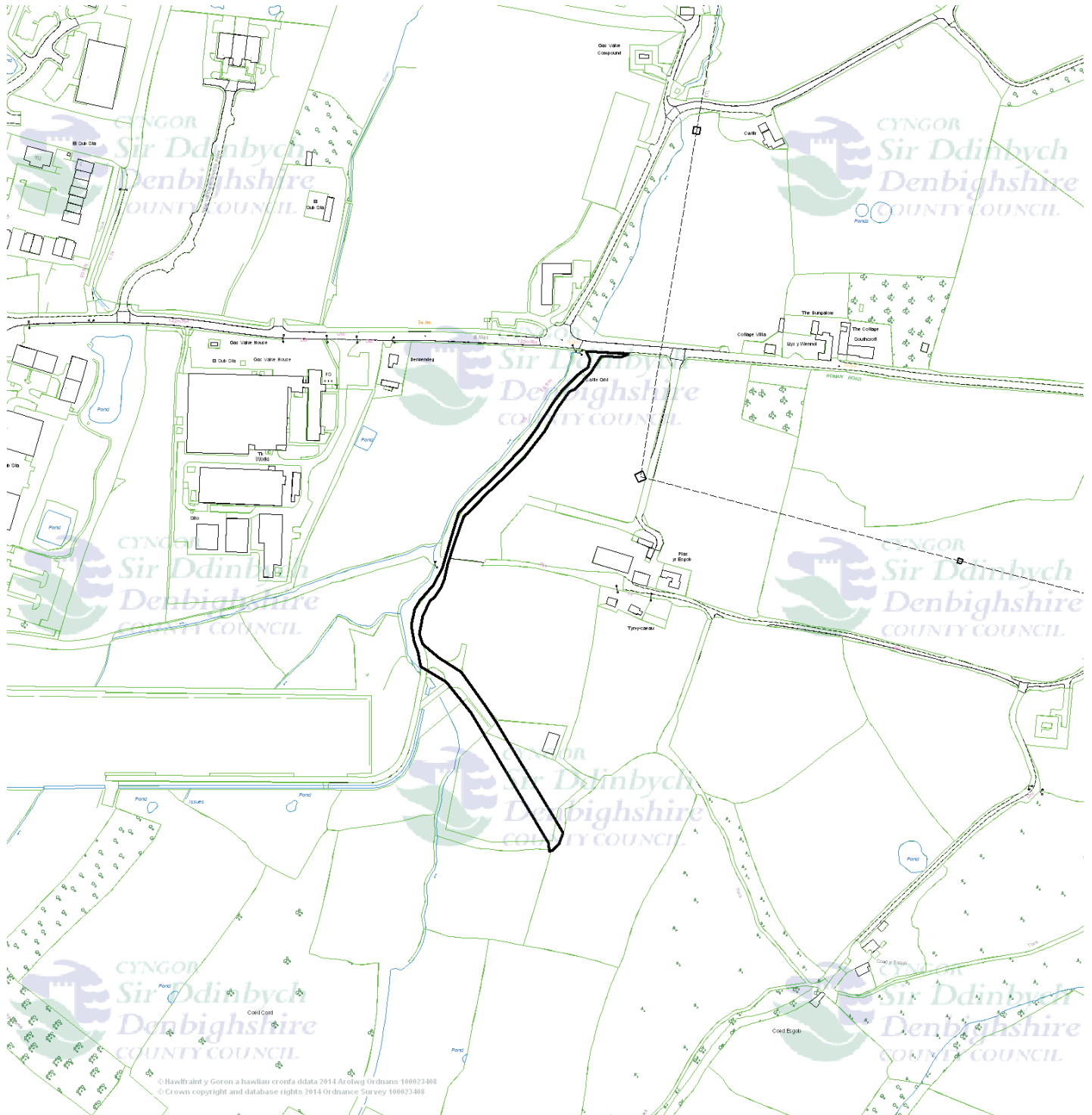

This map is reproduced from Ordnance Survey material with the permission of Ordnance Survey on behalf of the Controller of Her Majesty's Stationery Office. © Crown copyright. Unauthorized reproduction infringes Crown copyright and may lead to prosecution or civil proceedings. Denbighshire County Council. 100023408. 2011.

Atgynhychir y map hwn o ddeunydd yr Ordnance Survey gyda chaniatâd yr Ordnance Survey ar ran Rheolwr Llyfrfa Ei Mawrhydi © Hawlfraint y Goron. Mae atgynhychu heb ganiatâd yn torri hawlfraint y Goron a gall hyn arwain at erlyniad neu achos sifil. Cyngor Sir Ddinbych. 100023408. 2011.



PLAN A: APPLICATION SITE + CONSENTED BURBO BANK EXTENSION SITE



CYNGOR
Sir Ddinbych
Denbighshire
COUNTY COUNCIL

Date 29/5/2014

Scale 1/2000

Centre = 302087 E 373639 N

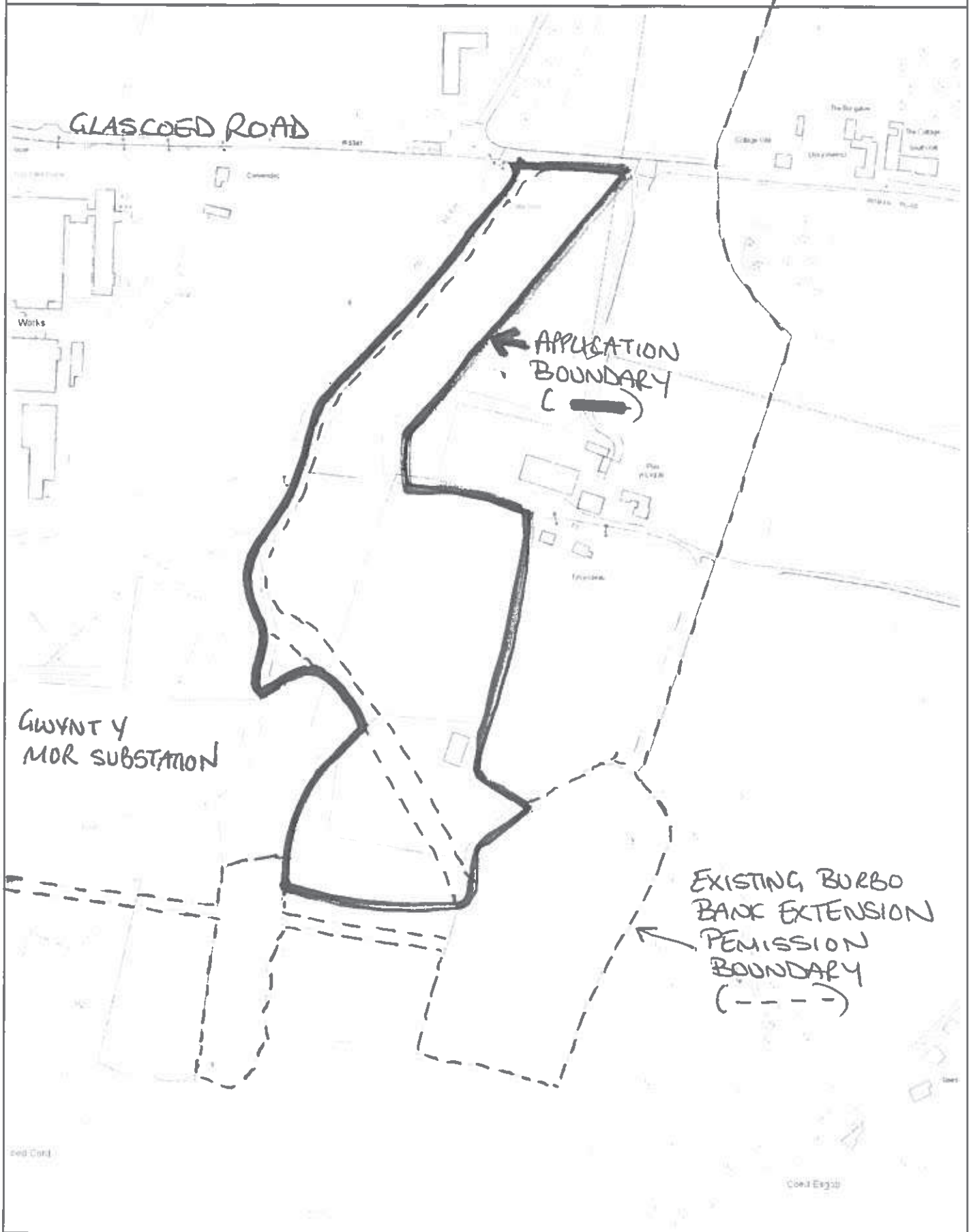

see Cont.

Coal Esgob



PLAN B: APPLICATION SITE + CONSENTED CARAVAN STORAGE SITE

Date 29/5/2014
 Scale 1/2000
 Centre = 302087 E 373639 N

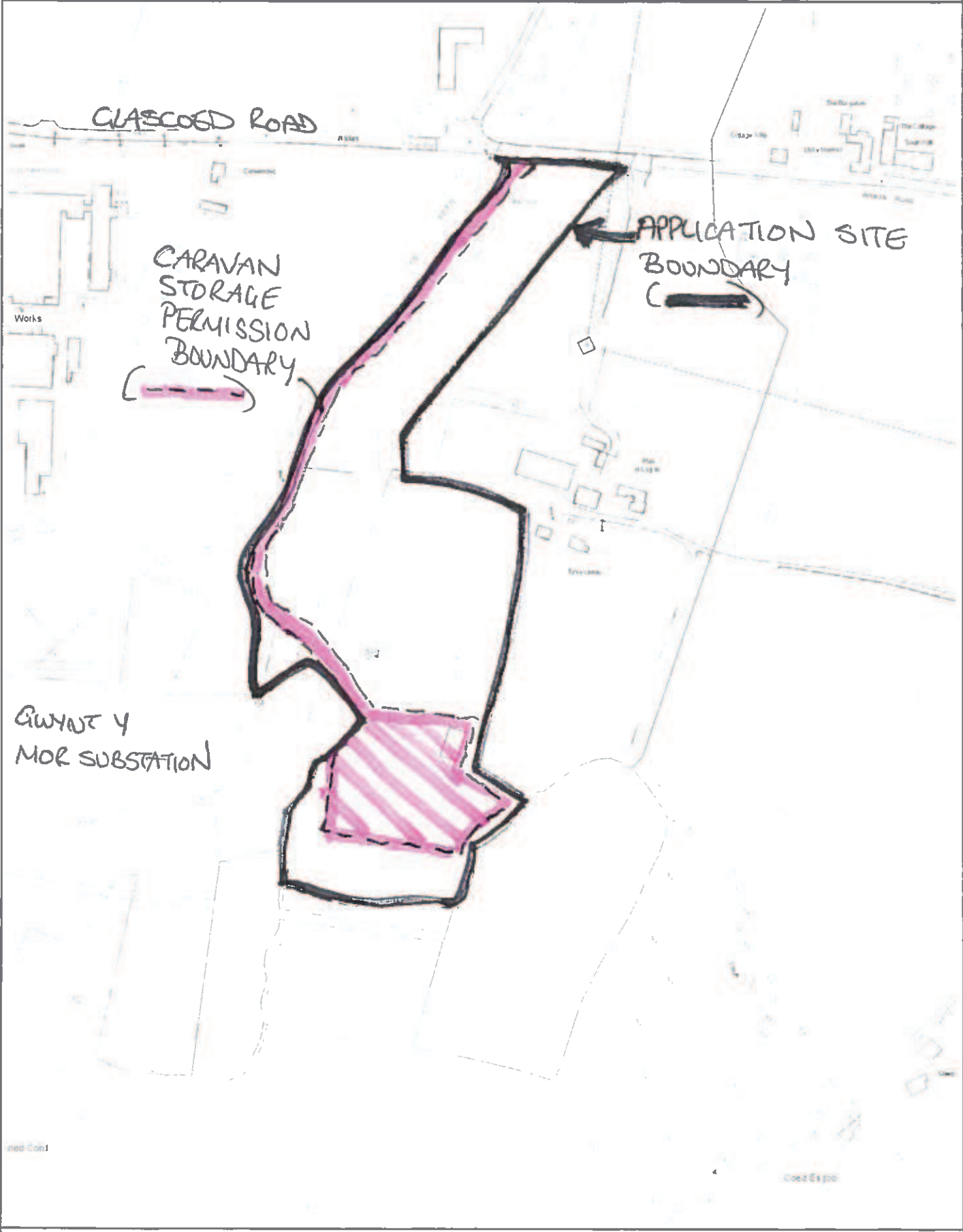

This is an extract of the millennium map TM which is copyright Getmapping Plc
 © Hewlett y Geron a hawley cronfa odata 2013 Arolwg Ordnans 100023408
 © Crown copyright and database rights 2013 Ordnance Survey 100023408

ITEM NO: 4

WARD NO: Trefnant

WARD MEMBER(S): Cllr Meirick Lloyd Davies

APPLICATION NO: 31/2014/0432/ PF

PROPOSAL: Continued use of land as a construction compound for up to 5 years to be used in association with Burbo Bank extension onshore works

LOCATION: Land south of St. Asaph Business Park (south) Glascoed Road St. Asaph

APPLICANT: Dong Energy Wind Power Ltd.Mr Stuart Livesey

CONSTRAINTS: PROW

PUBLICITY UNDERTAKEN: Site Notice – No
Press Notice – No
Neighbour letters - Yes

REASON(S) APPLICATION REPORTED TO COMMITTEE:
Scheme of Delegation Part 2

- Recommendation to grant / approve – Town / Community Council objection

CONSULTATION RESPONSES:

CEFN MEIRIADOG COMMUNITY COUNCIL “Cefn Meiriadog community councillors object to the renewal of this application for continued use. They would like the site to be returned to its former state and use.”

NATURAL RESOURCES WALES – NRW does not object to the proposal, but following recommendations are made:

Statutory Sites: will not affect any statutory sites

Protected Species: NRW consider the St. Asaph population of great crested newts to be of national importance. Great crested newts recorded recently within application area, and advise the following:

- Newt fencing is maintained throughout construction phase.
- Site should be restored to habitats suitable for great crested newts, and further compensation land will be required should permanent loss of great crested newt habitat occur.

Flood Risk: No overall flood risk objection. Draft Code of Construction Practice for Burbo Bank Extension proposed mitigation measures to reduce surface water flood risk and these measures should be implemented.

Environmental Management: Applicant is advised that the septic tank associated with the development requires an Environmental Permit and Contractors need to comply with Pollution Prevention Guidelines Nos. 1 to 6. Fuels/oils/chemicals should be bunded on site and securely stored.

DENBIGHSHIRE COUNTY COUNCIL CONSULTEES –
Head of Highways and Infrastructure

- Highways Officer – No Objection
- Footpaths Officer – No objection in principle. However, Public Rights of Way Footpath 16 & Bridleway 32 directly affected by the application. Developer is advised that Public Rights of Way will need to be made available to general public within the 5 year period.

Pollution Control Officer – No response at time of preparing report.

RESPONSE TO PUBLICITY: None received

EXPIRY DATE OF APPLICATION: 05/06/2014

REASONS FOR DELAY IN DECISION (where applicable):

- awaiting consideration by Committee

PLANNING ASSESSMENT:

1. THE PROPOSAL:

1.1 Summary of proposals

- 1.1.1 The application seeks permission to continue the use of land as a construction compound on land to the south of St. Asaph Business Park, Glascoed Road, St. Asaph in connection with the onshore works on the Burbo Bank Extension offshore windfarm for a period of 5 years.
- 1.1.2 The site was previously used as a temporary construction compound for the construction of the Gwynt y Mor substation.
- 1.1.3 The Burbo Bank Extension Wind Farm Onshore Works, which consists of an underground cable route and new substation, obtained planning consent in November 2013.
- 1.1.4 Condition 10 attached to the existing permission sets maximum noise limits for the substation. Whilst the design of the substation will be the subject of a separate reserved matters application, additional noise mitigation will be necessary to achieve compliance with condition 10 and an additional temporary construction compound is therefore required to enable the additional noise mitigation measures (e.g. noise enclosures) to be constructed.
- 1.1.5 The access to the site will be provided by a new access road consented by planning application 31/2013/0400. This will be the only access to the construction compound.
- 1.1.6 The applicant does not intend to increase the amount of hard standing presently within the existing construction compound and the existing 2.4m high chainlink fence and the new fence around the compound will remain in situ.
- 1.1.7 The temporary construction compound will be used to accommodate construction personnel, offices, toilets, mess facilities, traffic management, car parking facilities and storage areas for plant and machinery, and temporary mobile lighting will be used.
- 1.1.8 The proposed operational hours for the construction compound will be between the hours of 07:00 to 19:00 Monday to Friday and 08:00 to 13:00 on Saturdays, with 24 hour security.
- 1.1.9 A Code of Construction Practice is proposed.
- 1.1.10 The temporary use of the construction compound would be for a period of 5 years.
- 1.1.11 Construction works are anticipated to be completed by October 2017. The application states that, upon completion of construction activities, the laydown area will remain in situ and will be utilised for the storage of caravans by the land owners in accordance with planning permission granted on appeal in March 2014.

1.2 Description of site and surroundings

- 1.2.1 The application site is to the south of Glascoed Road approximately 500 metres to the south-east of the St. Asaph business park.
- 1.2.2 The site is formerly agricultural land.

- 1.2.3 Immediately to the west of the site is the Gwynt y Mor offshore windfarm substation and immediately to the east is the site for the consented Burbo Bank Extension offshore windfarm substation.
- 1.2.4 The nearest un-related residential property is Tyn-y-caeau approximately 120m to the north of the construction compound.
- 1.2.5 Two Public Rights of Way (footpath 16 and bridleway 32) are directly affected by the proposal. Footpath 16 runs along the haul road and bridleway 32 runs in an east-west direction approximately 130 to the north of the construction compound.

1.3 Relevant planning constraints/considerations

- 1.3.1 The site is un-annotated land outside of defined settlement boundaries. It is therefore in open countryside.
- 1.3.2 Public Rights of Way are directly affected by the proposal.

1.4 Relevant planning history

- 1.4.1 The applicant obtained planning consent in November 2013 for the Burbo Bank Extension onshore works, which consists of a underground high voltage electricity cable from Ffrith Beach, Prestatyn to St. Asaph, and a new substation on land to the south of Glascoed Road. The application site is immediately to the west of the consented substation location.
- 1.4.2 The application site has been in use as a temporary construction compound in association with the Gwynt y Mor offshore windfarm onshore works planning permission. The site is immediately to the east of the recently constructed Gwynt y Mor substation.
- 1.4.3 Planning permission was granted on appeal in March 2014 for the permanent retention of the previously formed site compound here for the use as a touring caravan storage area.

1.5 Developments/changes since the original submission

- 1.5.1 N/A

1.6 Other relevant background information

- 1.6.1 The Councils Footpaths Officer is in dialogue with the applicant over Public Rights of Way temporary closures to identify suitable routes for diverting the Public Rights of Way during the 5 year construction phase. This is a matter to be dealt with under highways legislation.

2. **DETAILS OF PLANNING HISTORY:**

- 2.1.1 31/2013/0400. Installation and operation of electrical substation compound with outdoor equipment, internal road layout & perimeter fencing south-east of St. Asaph Business Park and up to 11.14km of underground electricity cables between the St. Asaph substation and the coast at Ffrith Beach, Prestatyn, in connection with the proposed Burbo Bank offshore windfarm.
- 2.1.2 31/2008/1123. Installation of 132/400 kV electrical substation and associated underground 132 kV cables between St. Asaph and Pensarn in connection with proposed Gwynt y Mor offshore windfarm. Granted 18 February 2009.
- 2.1.3 31/2013/0767. Retention of a previously formed site compound for use as a touring caravan storage area. Granted on Appeal 7 March 2014 (Appeal Ref: APP/R6830/A/13/2206188).

3. **RELEVANT POLICIES AND GUIDANCE:**

The main planning policies and guidance are considered to be:
Denbighshire Local Development Plan (adopted 4th June 2013)

Policy VOE5 – Conservation of natural resources

Policy VOE 10 – Renewable energy technologies

Policy ASA 1 – New transport infrastructure

Policy ASA 3 – Parking standards

3.1 Supplementary Planning Guidance

3.2 Government Policy / Guidance

Planning Policy Wales Edition 6 February 2014

Technical Advice Notes

TAN 5 - Nature Conservation and Planning

TAN 8 - Renewable Energy

TAN 18 - Transport

3.3 Other material considerations

4. MAIN PLANNING CONSIDERATIONS:

In terms of general guidance on matters relevant to the consideration of a planning application, Planning Policy Wales Edition 6, February 2014 (PPW) confirms the requirement that planning applications 'should be determined in accordance with the approved or adopted development plan for the area, unless material considerations indicate otherwise' (Section 3.1.2). PPW advises that material considerations must be relevant to the regulation of the development and use of land in the public interest, and fairly and reasonably relate to the development concerned., and that these can include the number, size, layout, design and appearance of buildings, the means of access, landscaping, service availability and the impact on the neighbourhood and on the environment (Sections 3.1.3 and 3.1.4).

The following paragraphs in Section 4 of the report therefore refer to the policies of the Denbighshire Local Development Plan, and to the material planning considerations which are considered to be of relevance to the proposal.

4.1 The main land use planning issues in relation to the application are considered to be:

4.1.1 Principle

4.1.2 Residential amenity

4.1.3 Ecology

4.1.4 Highways (including access and parking)

4.1.5 Decommissioning / remediation

4.2 In relation to the main planning considerations:

4.2.1 Principle

The principle of renewable energy development is supported by Planning Policy Wales and LDP policy VOE 10.

This development would be ancillary to the Burbo Bank Extension offshore windfarm onshore works planning consent. To meet the noise limits specified in condition 10 attached to the Burbo Bank Extension planning permission, the current substation design, although not finalised, shows noise enclosures on the majority of the outdoor electrical equipment and noise walls on the substation perimeter will be required. An additional construction compound is necessary to construct the proposed noise mitigation measures.

The site has previously been in use as a construction compound for the construction of the Gwynt y Mor offshore windfarm substation and underground cables. The current proposal is for the continuation of the use of the land as a construction compound and it is not proposing to increase the operational land footprint or intensify the use of the land.

Cefn Meiriadog Community Council has objected to the principle of the development as they would like the site to be returned to its former state and use.

Whilst the intention was for the site to be restored to its former use once Gwynt y Mor construction activities had ceased, planning permission has subsequently been obtained on Appeal for the permanent retention of the construction compound for use as a touring caravan storage area, and therefore the Council can no longer require the land is restored whilst this permission remains extant. Whilst this permission has not yet been implemented, as it is extant, Officers consider significant weight should be apportioned to it.

As stated, the proposal has been put forward to enable the applicant to incorporate additional mitigation measures into the substation design in order to achieve the noise limits specified in Condition 10 to the Burbo Bank Extension permission. The continued use of this land as a temporary construction compound will therefore have a benefit in the longer term, once the substation becomes operational.

In light of the previously accepted use on the site, the existence of the extant planning permission and the longer term benefit in terms of enabling noise mitigation measures to be included within the substation design, Officers therefore suggest that the principle of the development is acceptable.

4.2.2 Residential amenity

Planning Policy Wales 3.1.4 refers to the number, size, layout, design and appearance of buildings, the means of access, landscaping, service availability and the impact on the neighbourhood and on the environment as potentially material considerations. The impact of a development on residential amenity is therefore a relevant test on planning applications.

There are no representations received raising concerns over residential amenity impacts.

The site has previously been in use as a construction compound. The current application is for the continuation of this use and it is not proposing to increase the operational land footprint or intensify the use of the land.

It is proposed that the construction compound will be operated between 07:00 and 19:00 Monday to Friday and 08:00 to 13:00 on Saturdays.

The Supporting Statement indicates that activities at the additional construction compound may emit noise or cause vibration but these effects will be localised and short term. Mitigation measures to reduce the effects of noise and vibration will be detailed in a Code of Construction Practice.

As the current proposal is not materially different to the previous established use, Officers therefore conclude that, subject to the inclusion of a planning condition requiring the a Code of Construction Practice being submitted to and approved by the local planning authority prior to commencement, the impact on residential amenity can be controlled, and the development would not therefore give rise to unacceptable adverse impacts on local residents.

4.2.3 Ecology

Policy VOE5 of the LDP requires due assessment of potential impacts on protected species or designated sites of nature conservation, including mitigation proposals, and suggests that permission should not be granted where proposals are likely to cause significant harm to such interests. This reflects policy and guidance in Planning Policy Wales (Section 5.2), current legislation and SPG 18- Nature Conservation and Species Protection, which stress the importance of the planning system in meeting the biodiversity objectives through promoting approaches to development which create new opportunities to enhance biodiversity, prevent biodiversity losses or compensate for losses where damage is unavoidable.

The Supporting Statement accompanying the application states that, as the site has already been developed for a construction compound, the proposal will not result in the loss of trees or hedgerows. Mitigation for great crested newts is currently in situ and will remain until the completion of the substation construction works.

NRW have not raised an objection to the proposal, but have requested a condition is applied to ensure the newt fences are maintained during the construction phase. NRW have also requested the site is restored to habitat suitable for great crested newts, and should the land be permanently be lost, compensation land should be secured.

The applicant has indicated that they are already in discussion with NRW regarding the existing newt fencing and the transfer of the responsibility of the Gwynt y Mor great crested

newt license to the applicant to enable the newt exclusion areas to be retained for use during the course of the Burbo Bank project. Officers consider this is a matter which can therefore be addressed under separate protected species legislation.

The Council can however, also apply a planning condition to requiring the site is decommissioned and remediated once the permission expires.

However, an extant planning permission exists for the permanent retention of the hardstanding and haul road. No planning condition was attached to this permission with respect to great crested newt. Therefore, should the landowner implement the extant permission, the Council cannot require great crested newt compensation land be provided under this permission.

Officers conclude that newt mitigation during the construction phase can be controlled through the protected species licence and therefore a planning condition requiring newt mitigation to be maintained would be unnecessary as it would duplicate another legislative process.

Subject to a planning condition being applied to ensure the site is decommissioned and remediated; Officers consider the proposal is not likely to have a significant adverse effect on biodiversity interests.

4.2.4 Highways (including access and parking)

Planning Policy Wales 3.1.4 refers to what may be regarded as material considerations and that these can include the number, size, layout, design and appearance of buildings, the means of access, landscaping, service availability and the impact on the neighbourhood and on the environment. The acceptability of the means of access is therefore a standard test on most planning applications.

Policy ASA 3 requires adequate parking spaces for cars and bicycles in connection with development proposals, and outlines considerations to be given to factors relevant to the application of standards. These policies reflect general principles set out in Planning Policy Wales (Section 8) and TAN 18 – Transport, in support of sustainable development.

Access to the substation will be from the existing private road off Glascoed Road via the St. Asaph Business Park.

The Environmental Statement accompanying the consented scheme acknowledged that there will be some disruption during the constructional phase from both deliveries to and from the temporary constructional compounds and from temporary traffic disruption caused by cable laying across the highways.

The supporting information with this application states that the use of the site as an additional construction compound will not have a significant effect over and above that already considered in the Environmental Statement for the consented scheme, and therefore the traffic and transport impact is considered neutral.

The Highways Officer has raised no objection to the scheme.

Officers are satisfied that the use of the land as an additional construction compound will not result in an unacceptable impact on traffic and transport. Highways impacts can be adequately controlled by a condition requiring a Code of Construction Practice Plan, incorporating a Traffic Management Plan to be submitted and approved prior to commencement of works.

With respect to Public Rights of Way, 2 Public Rights of Way are directly effected by the development proposal (footpath 16 and bridleway 32), both of which are currently closed under a temporary closure order. The Council's Public Rights of Way Officer has raised no objection to the proposal in principle and the applicant is already in discussion with the

Councils Footpaths Officer regarding the issue of further temporary closures and / or temporary diversions which has to be resolved under separate highways legislation.

4.2.5 Decommissioning / remediation of site

There are no specific policies in the adopted Denbighshire LDP relating to the re-instatement of land, hence the general considerations outlined in PPW need to be applied.

Extant planning permission exists for the permanent retention of the previously formed site compound (hardstanding and haul road) for use as a touring caravan storage area, and Officers believe it to be reasonable to attribute weight to the extant permission in the assessment of this application.

The touring caravan storage area permission has not yet been implemented. Condition 2 attached to the touring caravan storage area permission requires a detailed scheme of landscaping to be submitted to and agreed in writing by the local planning authority prior to commencement and this condition seeks to mitigate the visual impact of the site in the long term.

Whilst the current application is for the continued use of the land as a construction compound for a period of 5 years, from the supporting documents, construction works are likely to be completed in late 2017, and therefore the caravan storage permission could still be implemented after construction works have been completed (this in March 2019).

However, for the purposes of the current application, for the avoidance of doubt and in order for the Council to retain control over the use and appearance of the site in the long term, Officers consider it necessary to attach a planning condition to ensure a scheme for the decommissioning and remediation / re-instatement of the construction compound is submitted to the Council following completion of construction works, or before the expiry of the expiry of the 5 year period (whichever is the sooner).

5. SUMMARY AND CONCLUSIONS:

- 5.1 The purpose of using the land as a temporary construction compound for construction of the Burbo Bank Extension onshore works is in response to the need to incorporate additional noise mitigation features into the substation design.
- 5.2 The site has been used as a construction compound for the past 5 years and the applicant is not proposing to increase the footprint of operational land on site or intensify the use.
- 5.3 Whilst the Community Council have objected to the principle of the application and would prefer to see the land reinstated to its former use, as an extant permission exists for the permanent retention of the previously formed site compound for use as a touring caravan storage area, the Council cannot therefore require the site is reinstated whilst this permission remains extant. However, should planning permission be granted for this proposal, a condition should be attached requiring the land to be decommissioned and reinstated / remediated which would enable the Council to retain control over land in the long term should the extant permission not be implemented.
- 5.4 No other consultees have raised objection to the proposal and there have been no public responses.
- 5.5 NRW have not objected to the principle of the development, but have requested a condition is applied to ensure newt fences are maintained, and for the water, pollution, prevention and control measures to be applied, which Officers consider can be addressed by requiring the Code of Construction Practice Plan is agreed pre-commencement.
- 5.6 Whilst Public Rights of Way are directly affected by the proposal, this can satisfactorily be resolved under the provisions of the Highways Act 1980, and the applicant is already in discussion with the Council Officers to seek a solution.

5.7 Officers conclude that there would be no unacceptable adverse impacts arising as a result of the continued use of the land as a construction compound on a temporary basis, and are recommending the proposal should be granted subject to necessary planning conditions being applied.

RECOMMENDATION: GRANT - subject to the following conditions:-

The Conditions are:

1. The use of land as a temporary construction compound shall cease no later than 5 years from the date of this permission.
2. No development shall commence until a Code of Construction Practice Plan, incorporating a Traffic Management Plan and pollution, prevention measures to be implemented during the construction phase, has been submitted to and approved in writing by the local planning authority. The Statement shall include the following details:
 - (i) Programme and description of works;
 - (ii) Hours of operation;
 - (iii) Construction methodologies;
 - (iv) Material and plant storage/deliveries;
 - (v) Parking arrangements for site delivery, site operatives and visitors vehicles;
 - (vi) Wheel washing facilities;
 - (vii) Loading and unloading areas;
 - (viii) The erection and maintenance of security/safety fencing;
 - (ix) Site management and pollution, prevention and control measures (including arrangements for the safe storage of fuels/oils/chemicals to be kept on site);
 - (xi) Water drainage, including surface water drainage;
 - (xii) The movement of abnormal indivisible loads to the site.

The development shall be carried out in accordance with the approved Code of Construction Practice Plan, unless otherwise approved in writing with the Local Planning Authority.

3. Within 6 months of completion of construction works, or 3 months before the expiry of this permission, whichever is the sooner, a scheme for the decommissioning of the construction compound and the reinstatement and / or remediation of the land shall be submitted to, and approved in writing, to the local planning authority. The approved details shall be implemented within 3 months of the approval by the local planning authority being obtained.

The reason(s) for the conditions(s) is(are):

1. For the avoidance of doubt and in order that the Local Planning Authority retains control over the longer term use of the land.
2. In the interests of protect amenity, highway safety, water management and pollution, prevention and control.
3. To ensure the long term reinstatement and / or remediation of the site, in the interests of visual amenity.

NOTES TO APPLICANT:

Public Rights of Way Footpath 16 and Bridleway 32 are directly affected by this scheme. Currently they are closed under a temporary closure order. Please be advised that it is highly unlikely that further closures can be sought for the next 5 years.

You are therefore advised to contact the Council's Transport and Infrastructure team to discuss the options for stopping up and / or diverting Public Rights of Way under the Highways Act 1980.

You are advised that great crested newts have been recorded within the application site. You are therefore required to obtain a great crested newt licence under provisions of the Conservation of Habitats and Species Regulations 2010 (as amended) and no development should commence until a licence has been issued and newt mitigation is in place.

To make an application for a newt licence, please contact Natural Resources Wales:
Email: specieslicence@naturalresourceswales.gov.uk
Tel: 01248 385500

The Septic tank associated with the development will require an Environmental Permit from Natural Resources Wales unless an exemption applies. Please contact Natural Resources Wales for more information.

Contractors undertaking work at the compound must comply with guidance contained in Pollution Prevention Guidelines Nos. 1 to 6.

Heading:

REFERENCE NO. 46/2014/0438/PF
7 DEANS WALK
ST ASAPH

Graham Boase
Head of Planning & Public Protection
Denbighshire County Council
Caledfryn
Smithfield Road
Denbigh
Denbighshire LL16 3RJ

 Application Site



Date 3/6/2014
Centre = 303333 E 374182 N

Scale 1/1250

This plan is intended solely to give an indication of the LOCATION of the application site which forms the subject of the accompanying report. It does not form any part of the application documents, and should not be taken as representative of the proposals to be considered, which are available for inspection prior to the meeting.

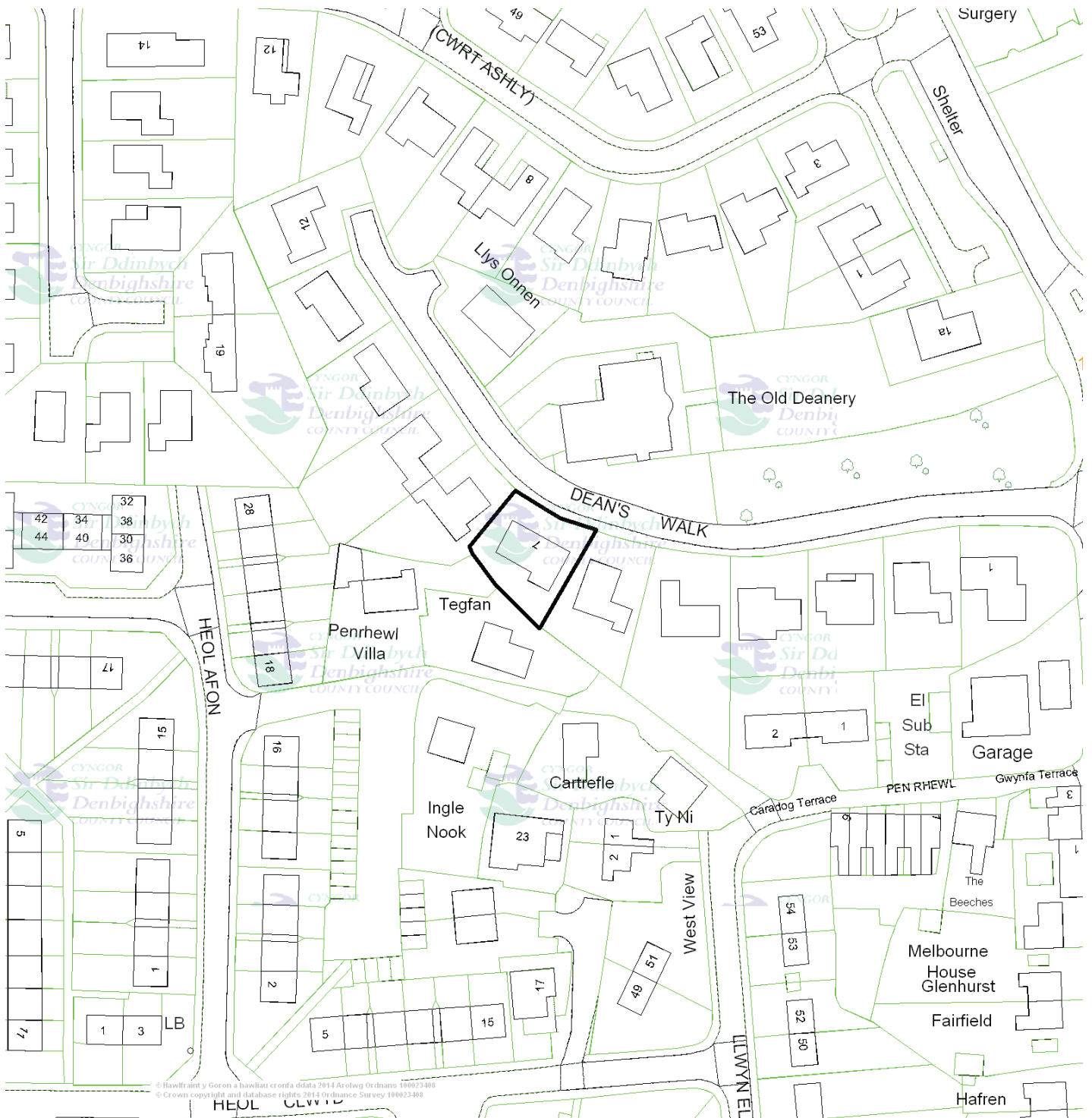

This map is reproduced from Ordnance Survey material with the permission of Ordnance Survey on behalf of the Controller of Her Majesty's Stationery Office. © Crown copyright. Unauthorized reproduction infringes Crown copyright and may lead to prosecution or civil proceedings. Denbighshire County Council. 100023408. 2011.

Atgynhyrchir y map hwn o ddeunydd yr Ordnance Survey gyda chaniatâd yr Ordnance Survey ar ran Rheolwr Llyfrfa Ei Mawrhydi © Hawlfraint y Goron. Mae atgynhyrchu heb ganiatâd yn torri hawlfraint y Goron a gall hyn arwain at erlyniad neu achos sifil. Cyngor Sir Ddinbych. 100023408. 2011.

SHED

SITE PLAN

46 / 2014 / 0438 / P C

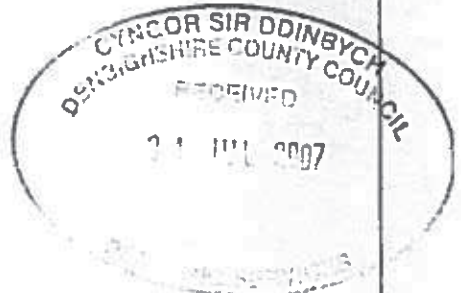
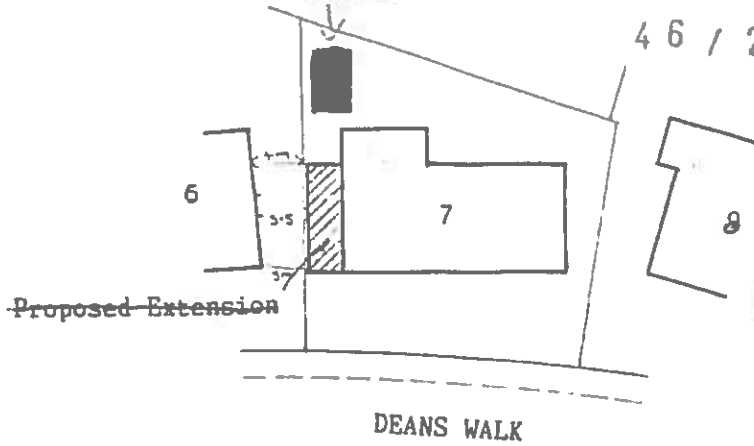

SITE PLAN SCALE - 1:500

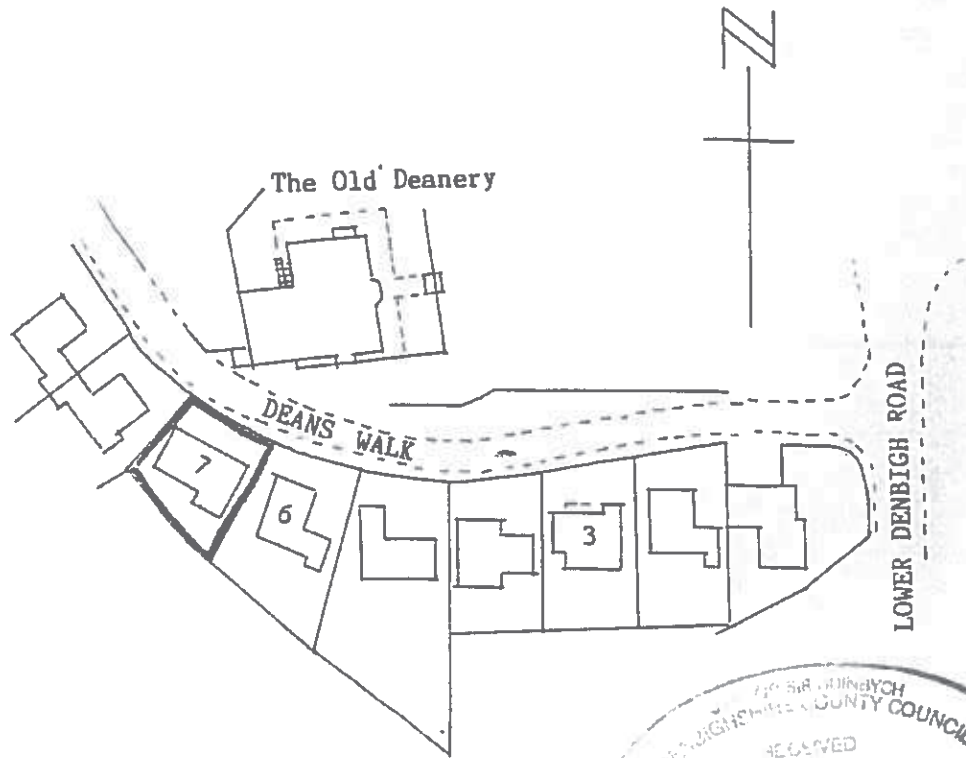

LOCATION PLAN SCALE - 1:1250

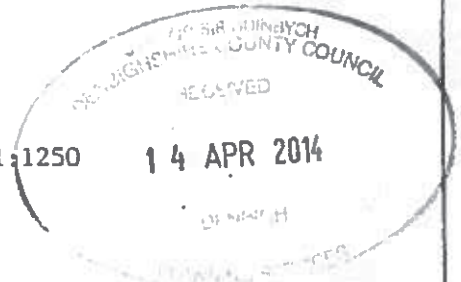

PLAN No. 2112/1/JUL/07

BRIAN E. ROBINSON, ABEng, MWOBO,
Planning & Design Services,
32 Clwyd Avenue, Rhuddlan,
Rhyl, Denbighshire. LL18 2UW.

Tel/Fax: 01745 591188 Mobile: 07946 537229

A Member of the Guild of Master Craftsmen.

ELEVATIONS

NIDA S33 NIP

46 / 2014 / 0438 / P C

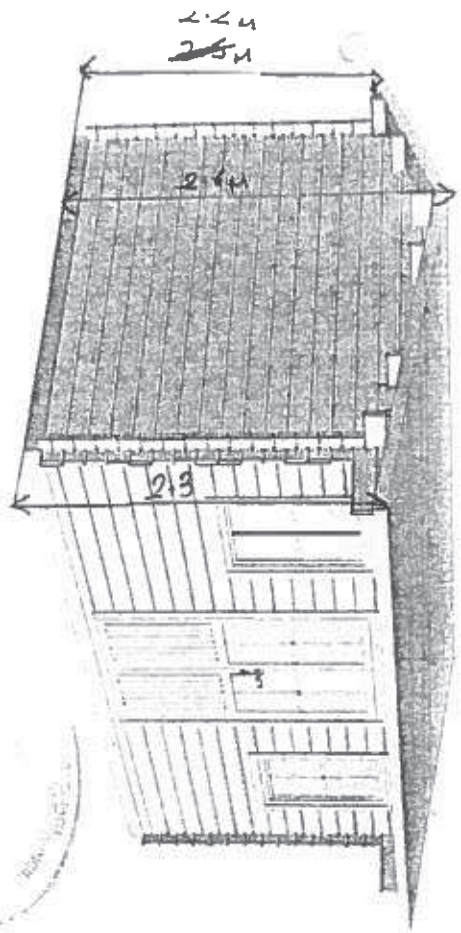
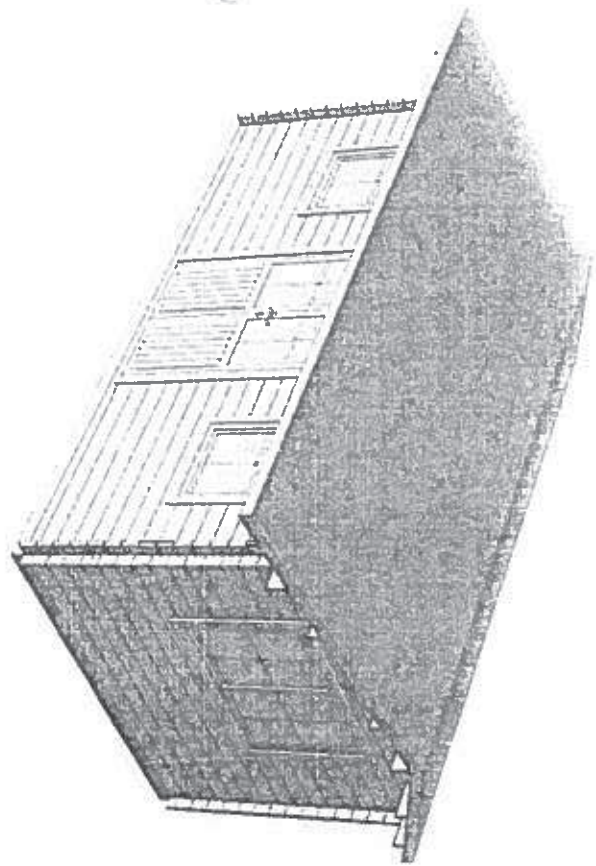

14 APR 2014

-22-

FLOOR PLAN

NIDA S33 NIP

46 / 2014 / 0438 / P C

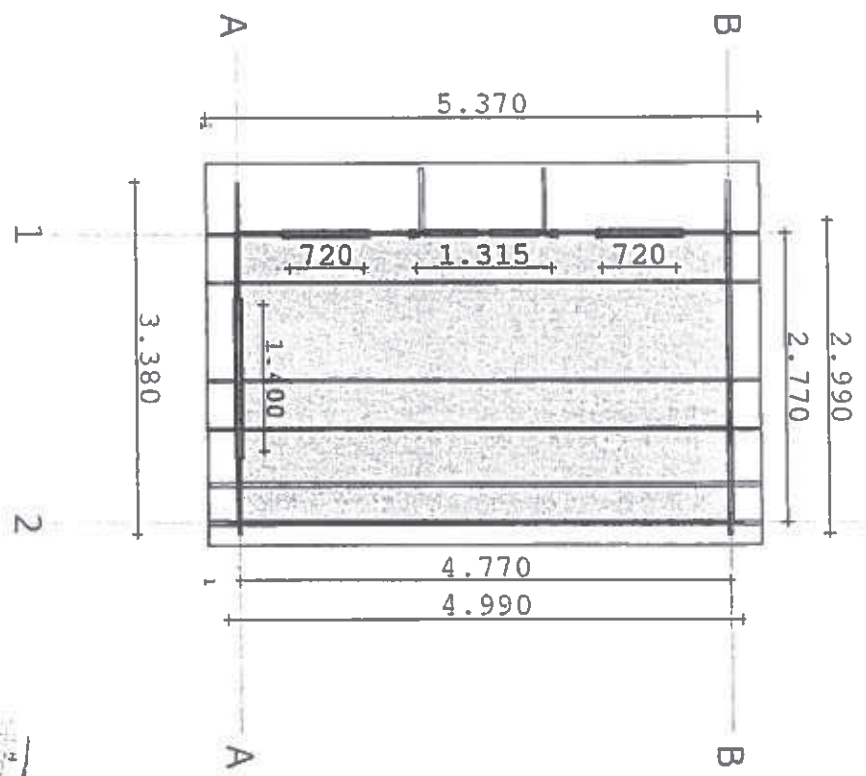

14 APR 2014

-5-

ITEM NO: 5
WARD NO: St Asaph West
WARD MEMBER(S): Cllr Cowie
APPLICATION NO: 46/2014/0438/ PC
PROPOSAL: Retention of garden storage shed (retrospective application)
LOCATION: 7 Deans Walk St Asaph
APPLICANT: MrMartin Bill
CONSTRAINTS: None
PUBLICITY UNDERTAKEN: Site Notice - NoPress Notice - NoNeighbour letters - Yes

REASON APPLICATION REPORTED TO COMMITTEE:
Scheme of Delegation Part 2

- Member request for referral to Committee
- Referral by Head of Planning / Development Control Manager

CONSULTATION RESPONSES:
CITY OF ST ASAPH TOWN COUNCIL
Comments awaited .

RESPONSE TO PUBLICITY:

In objection

Representations received from:

Mrs K McCormack, Tegfan, Penrhewl, St Asaph;
Mark Damrell and Ceri Evans, 6 Dean's Walk, St Asaph;
Mrs Lorna Mills, Penrhewll Villa, Penrhewl, St Asaph.

Summary of planning based representations in objection:

Visual / residential amenity

The structure is overly large for the size of garden in which it is placed / it is very close to the side and rear boundaries / the south facing window in the structure looks over the boundary wall into facing bedroom windows / it is used for domestic purposes and not for storage as suggested;

Drainage

The roof over the shed causes water to run off into the adjacent garden

EXPIRY DATE OF APPLICATION: 08/06/2014

REASONS FOR DELAY IN DECISION: Committee decision required.

PLANNING ASSESSMENT:

1. THE PROPOSAL:

1.1 Summary of proposals

- 1.1.1 The application seeks retrospective consent to retain a wooden log cabin type outbuilding which has been erected within the rear garden of the dwelling at 7 Deans Walk. The application forms refer to the proposal to be for a garden storage shed.
- 1.1.2 The cabin has a footprint of 3.0 metres by 4.8 metres with the roof overhanging to each side and therefore covering a larger area of 3.4 metres by 5.4 metres.
- 1.1.3 The structure has a pitched roof up to a height of 2.6 metres at the ridge with an eaves height of 2.3 metres to one side and 2.2 metres to the other due to a slightly off-centre pitch in the roof over the cabin. The outbuilding has a set of doors and two windows in the western side looking out over the applicant's own garden, and a further window in the southern end which directly looks out at the residential property immediately to the south (Tegfan).
- 1.1.4 The siting of the cabin is such that it immediately abuts the rear (south) and side (east) boundaries and is set within 0.5 metres of the rear elevation of the main bungalow. The structure is finished in a natural log design with a sloping green felt roof over.

1.2 Description of site and surroundings

- 1.2.1 The subject property is a detached bungalow set within a run of similar properties along the southern side of Dean's Walk in St Asaph, with the facing property to the other side of the road being The Old Deanery Nursing Home.
- 1.2.2 The bungalow has a relatively short rear garden depth of around 7 metres and a width of 20 metres, with its side and rear boundaries formed by walls of around 1.5 metres in height. The properties to the rear of the site are also bungalows with the nearest (Tegfan) having its front elevation facing the site and set around 5 metres off the rear boundary of the application site. The front (north) elevation of Tegfan contains the front door along with two habitable room windows.

1.3 Relevant planning constraints/considerations

- 1.3.1 The site stands within the development boundary in an area without any specific designation in the Local Development Plan.

1.4 Relevant planning history

- 1.4.1 The only history at the site relates to the addition of a single-storey extension to the eastern side of the property which was granted in 2007.

1.5 Developments/changes since the original submission

- 1.5.1 None.

1.6 Other relevant background information

- 1.6.1 None.

2. DETAILS OF PLANNING HISTORY:

- 2.1 46/2007/0949 - Erection of single-storey pitched-roof extension at side of dwelling: Granted 04/09/2007.

3. RELEVANT POLICIES AND GUIDANCE:

The main planning policies and guidance are considered to be:
Denbighshire Local Development Plan (adopted 4th June 2013)
Policy RD1 – Sustainable development and good standard design
Policy RD3 – Extensions and alterations to existing dwellings

- 3.1 Supplementary Planning Guidance
 - SPG 1 – Extensions to Dwellings
 - SPG 7 – Residential Space Standards
 - SPG 8 – Access for All
 - SPG 24 – Householder Development Design Guide

- 3.2 Government Policy / Guidance
 - Planning Policy Wales Edition 6 February 2014

4 MAIN PLANNING CONSIDERATIONS:

In terms of general guidance on matters relevant to the consideration of a planning application, Planning Policy Wales Edition 6, February 2014 (PPW) confirms the requirement that planning applications 'should be determined in accordance with the approved or adopted development plan for the area, unless material considerations indicate otherwise' (Section 3.1.2). PPW advises that material considerations must be relevant to the regulation of the development and use of land in the public interest, and fairly and reasonably relate to the development concerned., and that these can include the number, size, layout, design and appearance of buildings, the means of access, landscaping, service availability and the impact on the neighbourhood and on the environment (Sections 3.1.3 and 3.1.4).

The following paragraphs in Section 4 of the report therefore refer to the policies of the Denbighshire Local Development Plan, and to the material planning considerations which are considered to be of relevance to the proposal.

4.1 The main land use planning issues in relation to the application are considered to be:

- 4.1.1 Principle
- 4.1.2 Visual amenity
- 4.1.3 Residential amenity

4.2 In relation to the main planning considerations:

- 4.2.1 Principle

The principle of siting outbuildings in connection with existing dwellings is generally acceptable in terms of current policies, subject to consideration of detailing and impacts. Policy RD 3 relates specifically to alterations to dwellings and permits such work subject to the acceptability of scale and form; design and materials; the impact upon character, appearance, and amenity standards of the dwelling and its immediate locality; and whether the proposal represents overdevelopment of the site. SPG 1 and SPG 24 offer basic advice on the principles to be adopted when designing domestic developments. The assessment of impacts is set out in the following sections.

- 4.2.2 Visual amenity

Local Development Plan Policy RD 1 test (i) requires due regard to issues of siting, layout, form, character, design, materials, aspect, microclimate and intensity of use of land / buildings and spaces between buildings, which are matters relevant to the visual impact of development; test (iv) requires that development does not unacceptably affect prominent public views into, out of, or across any settlement or area of open countryside; test (v) requires the incorporation of existing landscape or other features, takes account of site contours, and changes in levels and prominent skylines; and test (xiii) requires the incorporation of suitable landscaping measures to protect and enhance development in its local context. SPG 1 and SPG 24 provide further advice on the extension and alteration of residential properties.

As the structure is set within the rear garden of the subject property, it is not visible when viewed from the north along Dean's Walk. The uppermost section of the cabin is visible when looking at the site from the south along Penrhewl, but only to a minor extent due to the boundary wall with only the roof, the rear window and part of the gable end of the outbuilding being seen.

On this basis, it is not considered that the retention of the outbuilding would result in any substantial harm to the visual amenity of the area on which a refusal of permission could be justified, and the scheme is therefore in accordance with Policy RD 1 along with the advice of the SPGs.

4.2.3 Residential amenity

Local Development Plan Policy RD 1 test (i) requires due regard to issues of siting, layout, form, character, design, materials, aspect, microclimate and intensity of use of land / buildings and spaces between buildings, which touch on the potential for impact on residential amenity; test (vi) sets the requirement to assess the impact of development on the amenities of local residents, other land and property users, or characteristics of the locality, in terms of increased activity, disturbance, noise, dust, fumes, litter, drainage, light pollution, etc.

The comments made by the adjacent occupiers whose properties are immediately to the side (east) and to the rear (south) are noted. In respect of the height of the outbuilding, the ridge is limited to 2.6 metres and the structure is not therefore adjudged to have an overbearing impact despite its proximity to the side and rear boundaries.

In Officers' opinion, the rear facing window in the cabin has a detrimental impact on the privacy and amenity of the occupiers to the rear at Tegfan who have two principal windows and their front doors facing this boundary due to the unusual juxtaposition of the properties. However, rather than seeking to refuse permission it is considered more appropriate to impose a condition which requires the removal of the southern facing window in the outbuilding to eliminate any detrimental impact on residential amenity to the adjacent occupiers to the south.

The other comments offered by the objectors relating to the use of the outbuilding are noted. Respectfully, it is not considered reasonable for a local planning authority to impose a condition on the use of a building within the curtilage of a dwellinghouse, to preclude use for normal domestic purposes in connection with that dwelling. If the use by the occupiers goes beyond normal domestic activity then this would be an enforcement matter, and if there is an issue with noise then this would need to be referred to the Public Protection section to determine whether there is a statutory nuisance to address.

It is not considered that the development represents an overdevelopment of the site, having regard to the remaining space around the dwelling and shed.

The question of water discharging from the roof into the neighbour's property is one that can be drawn to the applicant's attention by a suitably worded note to the applicant.

Having regard to the above, the scheme is considered to comply with the requirements of Policy RD 1 subject to the suggested condition requiring the removal of the rear facing window.

5 SUMMARY AND CONCLUSIONS:

- 5.1 In acknowledging the comments of neighbours, the retention of the building is considered acceptable and the application is recommended to be granted subject to the removal of the rear window.

RECOMMENDATION: - GRANT subject to the following conditions:-

1. The materials and finishes of the external surfaces of the walls and roof of the building hereby permitted shall be of the same texture, type and colour as those on external walls and the roof of the existing building.
2. The window fitted in the south facing elevation of the outbuilding shall be removed entirely and replaced with wooden planks to match the remainder of the existing south facing gable of the structure within 3 months of the date of this consent, and thereafter no additional windows shall be fitted into the outbuilding.

The reasons for the conditions are:-

1. In the interests of visual amenity.
2. In the interests of the residential amenity and privacy of adjacent occupiers

NOTES TO APPLICANT:

Dwr Cymru Welsh Water have advised that some public sewers and lateral drains may not be recorded on their maps of public sewers because they were originally privately owned and were transferred into public ownership by nature of the Water Industry (Schemes of Adoption of Private Sewers) Regulations 2011. The presence of such assets may affect the proposal. In order to assist Dwr Cymru Welsh Water in dealing with the proposal they request you contact their Operations Contact Centre on 0800 085 3968 to establish the location and status of the sewer. Under the Water Industry Act 1991 Dwr Cymru Welsh Water has rights of access to its apparatus at all times.

You are advised to ensure any roof water discharging from the building does not run onto adjacent property.

ADRODDIAD GAN Y PENNAETH CYNLLUNIO A GWARCHOD Y CYHOEDD

APÊL CYNLLUNIO

CODI AMLOSGFA GYDA MAES PARCIO CYSYLLTIEDIG, FFORDD FYNEDIAD A GERDDI COFFA, ADEILADU MYNEDIAD NEWYDD I GERBYDAU A GWAITH TRIN

TIR I'R GORLLEWIN O BARC BUSNES LLANELWY AR OCHR DDEHEUOL FFORDD GLASGOED, LLANELWY

CAIS RHIF. 31/2013/1069/PF

1. PWRPAS YR ADRODDIAD

- 1.1 Mae'r adroddiad hwn yn ymwneud â phenderfyniad y Pwyllgor Cynllunio i wrthod y datblygiad uchod, mae'r Cyngor wedi cael rhybudd ymlaen llaw gan yr ymgeiswyr bod apêl ffurfiol yn cael ei gyflwyno i'r Arolygiaeth Gynllunio, gyda chais i'r apêl gael ei drin drwy gyfrwng Ymchwiliad Cyhoeddus.
- 1.2 Bydd yr adroddiad yn rhoi gwybodaeth gefndirol berthnasol i'r Aelodau ac yn gofyn, wrth ddisgwyl cadarnhad gan yr Arolygiaeth Cynllunio bod y broses apelio wedi dechrau, bod yr Aelodau yn penodi dau gynrychiolydd i gynorthwyo gyda chyflwyno'r achos yn yr Ymchwiliad yn unol â Phara. 9.3 y Protocol Ymglymiad Aelodau ac Apeliadau Cynllunio. Bydd hefyd yn cyfeirio at yr angen i gael cynrychiolaeth gyfreithiol a phroffesiynol yn ystod y broses hon.

2. CEFNDIR

- 2.1 Mae'r apêl cynllunio wedi deillio o benderfyniad y Pwyllgor i wrthod cymeradwyo datblygu amlosgfa ar Ffordd Glasgoed, Llanelwy.
- 2.2 Cafodd y cais cynllunio ei gyflwyno'n wreiddiol yn Awst 2013, a chafodd ei ystyried yn y Pwyllgor Cynllunio ar 19 Mawrth 2014, gydag argymhelliad Swyddog i ROI caniatâd. Penderfynodd y Pwyllgor i WRTHOD caniatâd, a chytunwyd ar y rhesymau dros wrthod yng nghyfarfod dilynol y Pwyllgor ar 16 Ebrill 2014. Y rhesymau oedd:

"1. Mae'r cynnig yn cynnwys datblygu ardal o dir amaethyddol o ansawdd uchel o fewn y graddau a ystyrir fel 'y gorau a'r mwyaf amldefnydd' ym Mharagraff 4.10.1 o Bolisi Cynllunio Cymru, Rhifyn 6 (Chwefror 2014), y mae Llywodraeth Cymru yn ei ystyried o bwysigrwydd arbennig a dylid ei warchod fel adnodd cyfyngedig ar gyfer y dyfodol. Mae paragraff 4.10.1 yn ei gwneud yn ofynnol i Awdurdodau Cynllunio Lleol roi pwysau sylweddol i warchod tir o'r fath rhag cael ei ddatblygu, ac mae'n amlinellu ystyriaethau i'w defnyddio gyda chynigion wrth benderfynu ar geisiadau. Yn yr achos hwn, nid yw'r Awdurdod Cynllunio Lleol yn ystyried bod y

cais yn dangos na ellir bodloni'r angen ar naill ai dir a ddatblygwyd yn flaenorol neu dir o radd amaethyddol is yn yr ardal, neu bod safle'r cais yr un mwyaf addas ar gyfer y datblygiad, ac felly mae'r cynigion yn cael eu hystyried i fod yn groes i ofynion 4.10.1 o Bolisi Cynllunio Cymru Rhifyn 6.

2. Barn yr Awdurdod Cynllunio Lleol yw nad oes gan y safle gymwysterau hygrychedd da o ran mynediad i drafndiaeth gyhoeddus neu gerddwyr, mae'n gwrthdaro ag amcanion cynaliadwyedd yng Nghynllun Datblygu Lleol Sir Ddinbych (CDLI), Polisi ASA 2 o'r CDLI, amcanion Llywodraeth Cymru ym Mholisi Cynllunio Cymru Rhifyn 6 (Adran 8) a Nodyn Cyngor Technegol 18 - Trafnidiaeth, sy'n ceisio ymestyn y dewis mewn trafndiaeth a hygrychedd diogel mewn ffordd sy'n cefnogi datblygu cynaliadwy. Nid oes gwasanaeth bws yn mynd heibio i'r safle ac mae'r arosfannau bws agosaf dros 500 metr i'r dwyrain ar Barc Busnes Llanelwy, heb unrhyw gyswllt llwybr troed ar hyd y B5381 o gylchfan y Parc Busnes i'r dwyrain o'r safle, gan gyfyngu mynediad ar gyfer car modur i'r amlosgfa. Nid yw cynnig yr ymgeiswyr i ddarparu arosfannau bws yn agosach at y safle a'r posibilrwydd o ariannu cynnydd mewn gwasanaethau sy'n mynd heibio i'r safle yn cael eu hystyried yn ddigon datblygedig i warantu lefel dderbyniol o hygrychedd i'r safle drwy ddulliau eraill heblaw gar modur yn ystod oes y datblygiad."

- 2.3 Cafodd y penderfyniad i wrthod caniatâd ei gynnig gan y Cynghorydd Bill Cowie ac eiliwyd gan y Cynghorydd Arwel Roberts.
- 2.4 Cafodd y Dystysgrif Penderfyniad ffurfiol ei dyddio 16 Ebrill 2014.
- 2.5 Mae yna oblygiadau costau sylweddol posibl yn codi o ddelio â'r apêl drwy broses yr Ymchwiliad Cyhoeddus. Bydd hyn yn gorfodi'r Cyngor i gynnwys bargyfreithiwr i wynebu'r achos, a chan fod y penderfyniad i wrthod yn groes i argymhelliad y Swyddog, bydd hefyd angen ystyried cyflogi ymgynghorydd cynllunio i amddiffyn y ddau reswm dros wrthod, o ystyried na fyddai Swyddogion y Cyngor oedd yn cymryd rhan yn yr achos yn gallu cyflwyno tystiolaeth yn groes i'w barn broffesiynol a fynegwyd yn y cam ymgeisio. Mae'n debygol y bydd costau amddiffyn yr apêl oddeutu £10,000 - £15,000, gan adael o'r neilltu y potensial ar gyfer unrhyw hawliadau am gostau llwyddiannus y gellir eu cyflwyno gan yr apelyddion yn yr Ymchwiliad.
- 2.6 Fel sy'n wir mewn sefyllfaoedd tebyg, bydd Swyddogion y Cyngor yn darparu'r cymorth gweithdrefnol angenrheidiol yn ystod proses yr Ymchwiliad.

3. Y PENDERFYNIAD A GEISIR

- 3.1 Gan fod y penderfyniad i wrthod yn groes i argymhelliad y Swyddog, mae angen dilyn y Protocol a fabwysiadwyd ar gyfer ymdrin ag Apeliadau Cynllunio a Chynnwys Aelod, a dyna pam y gofynnir am benderfyniad y Pwyllgor ar y canlynol:

Mae paragraff 9.3 yn nodi:

"Bydd yn ofynnol i Aelodau'r Pwyllgor Cynllunio roi tystiolaeth mewn ymchwiliad neu wrandawriad anffurfiol mewn apeliadau lle mae argymhelliad swyddog wedi ei wrthdroi. Bydd y Pwyllgor Cynllunio'n penodi cynrychiolwyr i roi tystiolaeth yn y gwrandawriad/ymchwiliad (fel arfer cynigydd ac eilydd y cynnig)".

- 3.2 Mae gofyn i'r Pwyllgor wneud penderfyniad ynglŷn â'r angen i gynnwys Bargyfreithiwr ac ymgynghorydd Cynllunio i gyflwyno achos y Cyngor, gan ganiatáu i Swyddogion symud ymlaen gyda'r trefniadau angenrheidiol mewn pryd ar gyfer paratoi'r Datganiad Achos cychwynol, y Prawf Tystiolaeth dilynol, a chyflwyno tystiolaeth yn yr Ymchwiliad ei hun.

4. ARGYMHELLIAD

- 4.1 Bod y Pwyllgor Cynllunio yn penodi dau gynrychiolydd i roi tystiolaeth yn yr Ymchwiliad.
- 4.2 Bod y Pwyllgor Cynllunio yn cytuno i gynnwys Bargyfreithiwr ac Ymgynghorydd Cynllunio i amddiffyn y rhesymau dros wrthod.

GRAHAM H. BOASE

PENNAETH CYNLLUNIO A GWARCHOD Y CYHOEDD

Mae tudalen hwn yn fwriadol wag

Adroddiad i'r:	Pwyllgor Cynllunio
Dyddiad y Cyfarfod:	18 Mehefin 2014
Adroddiad Gan:	Pennaeth Cynllunio a Gwarchod y Cyhoedd
Awdur yr Adroddiad:	Rheolwr Datblygu
Teitl:	Dadansoddiad o Apeliadau Cynllunio 2013/14

1. Am beth mae'r adroddiad yn sôn?

Mae'r adroddiad yn darparu dadansoddiad manwl o'r holl benderfyniadau a wnaed ynglŷn ag apeliadau cynllunio o Ebrill 2013 hyd heddiw.

2.

Darparu gwybodaeth am berfformiad yr Awdurdod Cynllunio Lleol mewn perthynas ag apeliadau cynllunio fel y gall yr Aelodau graffu ar achosion unigol.

3. Beth yw'r argymhellion?

Bod yr Aelodau'n nodi cynnwys yr adroddiad ac yn codi unrhyw faterion ynglŷn ag achosion penodol gyda Swyddogion y tu allan i'r Pwyllgor Cynllunio.

4. Manylion am yr adroddiad.

Cefndir

Gellir cyflwyno apêl Cynllunio wedi i Gyngor Sir Ddinbych, fel yr Awdurdod Cynllunio Lleol, wrthod cais cynllunio. Gellir gwneud penderfyniad o'r fath i wrthod cais gan y Pwyllgor Cynllunio neu gan Swyddogion dan ddarpariaethau'r Cynllun Dirprwyo mabwysiedig. Mae'r Cynllun Dirprwyo cyfredol ynghlwm yn **Atodiad 1**.

Gellir ystyried apeliadau cynllunio drwy un o dri dull. Nodir y rhain isod:-

- **Sylwadau Ysgrifenedig** - Cyfnewid datganiadau rhwng y Cyngor a'r apelydd trwy'r Arolygiaeth Gynllunio. Fel arfer mae hyn yn broses syml a chyflym gydag ychydig iawn o gostau i naill barti na'r llall.
- **Gwrandawriad Anffurfiol** - Cyfnewid datganiadau rhwng y Cyngor a'r apelydd trwy gynnal trafodaeth o amgylch y bwrdd gyda'r Arolygydd Cynllunio wedi ei drefnu dros 1 diwrnod. Gall y ddwy ochr wneud cais am gostau ac mae'n golygu ychwanegu amser Swyddogion / Aelodau i fynychu gwrandawriad undydd.
- **Ymchwiliad Cyhoeddus** - Cyfnewid datganiadau a thystiolaeth rhwng y Cyngor a'r apelyddion trwy gynnal ymchwiliad ffurfiol a fydd wedi ei drefnu gan yr Arolygiaeth Gynllunio. Mae angen cynrychiolaeth gyfreithiol gogyfer ag Ymchwiliadau gan y bydd croesholi'n digwydd ynglŷn â'r dystiolaeth. Gall fod

yn gostus oherwydd bod cyfreithwyr ynghlwm â hyn ac oherwydd y ffaith y gall apeliadau ymestyn dros 3 neu 4 diwrnod.

Yn ddiweddar bu Cyngor Sir Ddinbych yn rhan o **Wasanaeth Apelio Deiliaid Tai**. Cafodd y broses hon ei sefydlu i gyflymu'r broses o gynnal gwrandawriad ynglŷn â'r math o achosion syml hynny sy'n apelio yn erbyn gosod estyniadau i anheddau. Ni chaiff datganiadau eu cyfnewid yn y broses hon, ond bydd yr Arolygiaeth yn gwneud penderfyniad yn seiliedig ar y cais cynllunio a gyflwynwyd ac ar unrhyw ddogfennau perthnasol eraill megis yr adroddiad Pwyllgor neu adroddiad y Swyddog Dirprwyedig.

Yn amlwg byddai'r Cyngor yn ceisio amddiffyn unrhyw benderfyniad i wrthod rhoi caniatâd cynllunio ac yn gobeithio bod yr Arolygiaeth Gynllunio yn diystyru apêl yr apelyddion. Weithiau, fodd bynnag, am amrywiaeth o resymau, bydd yr Arolygiaeth Gynllunio yn **caniatáu** apêl. Mae'n bwysig, felly, bod modd inni ddadansoddi penderfyniadau'r apeliadau hyn i weld a oes unrhyw wersi i'w dysgu gan Swyddogion, Aelodau a phartïon allweddol eraill megis Cyngorau Tref a Chymuned yn y broses apelio.

Ni all y Cyngor ragweld sawl apêl cynllunio gaiff eu cyflwyno dros gyfnod o flwyddyn gan mai penderfyniad yr ymgeisydd ar bob adeg yw p'un ai i apelio neu beidio.

Dylai'r Cyngor geisio bob amser i sicrhau bod unrhyw benderfyniad i wrthod rhoi caniatâd cynllunio y mae'n ei wneud yn gadarn ac yn seiliedig ar dystiolaeth. I'r perwyl hwn gwnaethpwyd ymdrechion i leihau'r risg bod penderfyniadau gwrthnysig posibl yn cael eu gwneud gan y Cyngor. Mae cyfathrebu gwell rhwng Swyddogion/Aelodau yn ystod y broses o wneud cais cynllunio, hyfforddiant sy'n ymwneud â chynllunio ar gyfer Aelodau a Chynghorau Tref/Cymuned ynghyd â phroses Apeliadau Cynllunio wedi ei chydlynw wedi gwasanaethu'r Cyngor yn dda er mwyn osgoi'r risg o ddyfarnu costau yn erbyn y Cyngor. Fodd bynnag, o fewn proses ddemocrataidd bydd rhywfaint o risg o hyd y gwneir penderfyniadau gan yr Arolygiaeth Gynllunio yn groes i farn y Cyngor.

Dadansoddi Apeliadau 2013/14

Mae **Atodiad 2** y ddogfen hon yn dadansoddi pob un o'r 18 penderfyniad apêl y mae'r Cyngor wedi eu cael o Ebrill 2013 hyd heddiw. Mae rhai o ffigyrau pwysicaf y dadansoddiad hwnnw wedi eu cynnwys fel pwyntiau bwled islaw'r tabl.

Dylai swyddogion sylwi y byddai'r apeliadau hynny yr ymdriniwyd â hwy cyn Mehefin 2013 yn berthnasol i'r hen Gynllun Datblygu Unedol. O fis Mehefin 2013 ymlaen mae'r penderfyniadau sydd wedi eu gwneud yn berthnasol i'r Cynllun Datblygu Lleol newydd.

Dim ond tynnu sylw at y data perthnasol y mae'r wybodaeth sydd wedi ei chynnwys yn yr atodiad ac nid yw'n cynnig dadansoddiad o'r penderfyniadau. Bydd swyddogion bob amser yn ceisio dod ag adroddiadau penodol ger bron y Pwyllgor Cynllunio pe deuai penderfyniad apêl i law sy'n tynnu sylw at rai meysydd polisi allweddol o ddiddordeb. Yn ogystal, bydd Swyddogion o dro i dro yn darparu digwyddiadau hyfforddi i Aelodau sy'n dadansoddi penderfyniadau apêl, dehongliadau Polisi a thueddiadau mewn rhagor o fanylder.

Mae tudalen hwn yn fwriadol wag

PLANNING AND PUBLIC PROTECTION

DEVELOPMENT CONTROL AND COMPLIANCE SECTION AND BUILDING CONTROL SECTION

SCHEME OF DELEGATION

The delegation scheme enables officers within the Building Control Section and Development Control & Planning Compliance Section of the Service to deal with certain defined determinations without authorisation from Members.

The purpose of having such a Scheme of Delegation is to ensure an efficient, customer focussed approach whilst maintaining the necessary democratic checks and balances which Planning Committee and Full Council provide.

1. BUILDING CONTROL SECTION SCHEME OF DELEGATION

Building Regulations are made under Part 1 of the Building Act 1984 and are exercisable by statutory instrument through empowerment of Local Authorities to ensure their requirements are met.

Provisions for dealing with defective premises, dangerous buildings and demolitions are set out in Part 3 of the Building Act in Sections 76 - 83 inclusive empowering Local Authorities to serve notices, execute works in default and recover expenses.

The scheme will authorise the Head of Planning and Public Protection, Building Control Manager and any Officer within the Building Control Section so authorised by them to deal with ALL Building Regulations work as set out in the provisions of the Building Act 1984.

2. DEVELOPMENT CONTROL & PLANNING COMPLIANCE SECTION SCHEME OF DELEGATION

Part 1 – Officer Level Decisions

Part 2 – Committee Level Decisions

2.1. PART 1 – OFFICER LEVEL DECISIONS

The scheme will allow the Head of Planning and Public Protection, Development Control & Planning Compliance Manager and any Officer within the Development Control & Planning Compliance Section so authorised by them to determine the following types of applications, prior determinations, notifications, approval of conditions, ancillary decisions, amendments and compliance case under the relevant Planning Acts:-

Planning or other Applications

- 2.1.1. All types of planning or other applications on which Officers are recommending approval where 3 or less individual written objections have been received from different individuals raising material planning objections.
- 2.1.2. All types of planning or other application on which Officers are recommending refusal.
- 2.1.3. All types of prior determinations, neighbouring authority notifications, the need for Environmental Impact Assessments (screening and scoping opinions) and other notifications.

Compliance Issues

- 2.1.4. Compliance cases which have been investigated by a Planning Compliance Officer and require no further action.
- 2.1.5. Compliance cases which require the serving of a planning related enforcement notice.*
- 2.1.6. Legal action in association with breaches of Notices served under the provisions contained in paragraph 2.1.5 above. Legal action will not be taken until the Local Member(s) have been made aware, and agreed to the action to be taken.

Miscellaneous

- 2.1.7. Decide the type of planning appeal, subject to consultation with the Local Ward Member(s), and undertake to defend the Council's position in accordance with the Protocol for Member Involvement in Planning Appeals.
- 2.1.8. To submit observations on behalf of the Council on external consultations or draft documents.
- 2.1.9. Minor amendments to the terms of a Section 106 legal agreement where the substance of the authorised terms has not significantly altered, subject to informal consultation with the Local Ward Member(s).

- 2.1.10. Minor amendments to the wording of planning conditions / notes to applicants on applications approved at Planning Committee, including minor amendments to Committee authorised enforcement notices where the substance of the suggested condition / note to applicant / notice has not significantly altered, subject to informal consultation with the Local Ward Member(s).
- 2.1.11. To submit observations on behalf of the Council on the following pre-application stages of major renewable energy infrastructure projects:-
- Responding to the Infrastructure Planning Commission (IPC's) environmental impact assessment (EIA) scoping opinion consultation
 - Responding to the developer's consultation on the draft Statement of Community Consultation (SoCC)
 - Responding to the IPC's consultation on the adequacy of the developer's pre-application consultation
- 2.1.12 To make and serve Tree Preservation Order Notices and deal with applications for works to trees having a Preservation Order or works to Trees in Conservation Areas.

2.2. PART 2 – COMMITTEE LEVEL DECISIONS

The following sets out the types of applications which will need to be reported to Planning Committee for formal determination and as such do not fall within Part 1 of this scheme:-

- 2.2.1. All types of planning or other applications on which Officers are recommending approval where 4 or more individual written objections have been received from different neighbours/residential properties raising material planning objections.
- 2.2.2. All types of planning or other applications on which Officers are recommending approval where a relevant material planning objection has been received from a Town/Community Council or body required to be consulted under the provisions of The Town and Country Planning (General Development) Procedure Order.
- 2.2.3. All applications on which Officers are recommending approval which represent a significant departure from the adopted policies and guidance of the Development Plan.
- 2.2.4. Any application not already determined under Part 1 above which the Ward Member, for the Ward in which the application is located, has submitted a written request based on valid planning grounds that application be heard at Planning Committee. The request should be made as soon as possible after notification of receipt of the application by the Ward Member to the Head of Planning and Public Protection and/or the Development Control & Planning Compliance Manager.
- 2.2.5. Any application submitted by, on behalf of, or on land in the ownership of:
 - A County Councillor,
 - Member of the Senior Leadership Team (SLT)
 - Member of staff of Planning and Public Protection
 - A close relative of any of the above
- 2.2.6. Any application to remove or vary a planning condition which has been specifically imposed by Members at Planning Committee or Full Council.
- 2.2.7. Any application to vary or modify any fundamental terms of a Section 106 legal agreement which is linked to a planning permission given at Planning Committee.
- 2.2.8. Any other application, compliance case or determination which the Head of Service or Development Control & Planning Compliance Manager considers necessary to report to Planning Committee due to interest or circumstance.

- 2.2.9 Any formal pre-application (Section 42) consultation on Infrastructure Planning Commission (IPC) schemes along with the formal application made to the IPC (Local Impact Report) and any other formal representations at examination stage.
- 2.2.10 Any application which has been determined at Committee previously but which, in the opinion of the Head of Planning and Public Protection in consultation with the Monitoring Officer, could represent one of the following:-
- a) a significant departure from the adopted Development Plan.
 - b) An application where there could be a significant risk of costs awarded against the Council at any subsequent planning appeal, legal challenge, possible Welsh Government call-in or Ombudsman investigation.
- 2.2.11 The returning report will, in all circumstances, be presented back to Committee in order protect the interests of the Council and will contain additional information pertaining to the two areas a) and/or b) above.

FOR CLARITY REGARDING THE DEVELOPMENT CONTROL & PLANNING COMPLIANCE SCHEME OF DELEGATION:

For the purposes of this scheme all planning applications will include those made by or on behalf of the Council.

Letters of representation will only be taken into account for the purposes of defining whether an application falls within Part 1 or Part 2 of the Scheme of Delegation if they are signed and addressed.

Anonymous letters of representation will not be taken into account for the purposes of defining whether an application falls within Part 1 or Part 2 of the Scheme of Delegation.

Petitions containing names/signatures only will be counted as one single representation for the purposes of defining whether an application falls within Part 1 or Part 2 of the Scheme of Delegation.

Petitions containing clearly written names along with associated addresses will be defined for the purposes of whether an application falls within Part 1 or Part 2 of the Scheme of Delegation as if each name was a separate representation.

All electronic submissions will only be taken into account for the purposes of defining whether an application falls within Part 1 or Part 2 of the Scheme of Delegation if they contain an individuals name and associated address.

“Close relative” is defined as spouses/partners, parents, children, brothers and sisters.

“Significant Departure” is defined as any proposal which, if approved or refused, would harm the fundamental intentions of a Policy in the Development Plan.

For the purposes of this scheme “Specific function exercised by the Council” will include any development required to ensure the function and operation of the Council’s agricultural estate.

For “Bodies required to be consulted under Procedure Order” please refer to latest Procedure Order

*For the purposes of this scheme “Any Planning Related Enforcement Notice” includes Stop Notices, Temporary Stop Notices, Injunctions, Listed Building Enforcement Notices, Urgent Works Notices, Discontinuance Notices (Adverts), S215 untidy land notices, breach of condition notice and repairs notice.

Author : Paul Mead	Date adopted at Planning Committee :
Contact : Judith Williams	Version : 5
	Date to be reviewed : 01/06/14

APPEAL ANALYSIS 2013-14

	<u>Appeal Case</u>	<u>Decision Date</u>	<u>Decision</u>	<u>Appeal Type</u>	<u>Officer Recommendation</u>	<u>Committee Decision</u>	<u>Town Council Response</u>
1	45/2012/1163/PF - 1 Willow Court, Rhyl <i>Retention of 1.8m high front boundary fencing</i>	21/05/2013	Dismiss	Written	Refuse	Refuse	Object
2	43/2012/1128/PF - 18 Ffordd Ffynnon, Prestatyn <i>Erection of extensions to front and rear including side dormer features</i>	05/07/2013	Dismiss	Informal	Refuse	Refuse	No objection
3	47/2012/0425/AG - Part field No. 8100 Bryn Farm, St Asaph <i>Prior approval for the erection of a steel framed storage building</i>	02/07/2013	Dismiss	Written	Refuse	N/A	N/A
4	45/2012/1490/PF - Next, 56 High Street, Rhyl <i>Change of use from Class A1 shop to Class A2 financial and professional</i>	08/07/2013	Dismiss	Written	Refuse	Refuse	No objection
5	45/2012/1519/PF - Next, 56 High Street, Rhyl <i>Change of use of Class A1 shop to Class A3 food and drink use</i>	08/07/2013	Dismiss	Written	Refuse	Refuse	Object
6	01/2012/1350/LE - Caravan at the Airfield, Lleweni Parc, Denbigh <i>Certificate of lawfulness for a manager's residential caravan</i>	02/08/2013	Dismiss	Written	Refuse	N/A	N/A
7	40/2013/0063/PF - Tyddyn Gwynfa, Coed Avenue, Rhyl <i>Erection of extensions to side and rear of dwelling</i>	13/08/2013	Dismiss	Written	Refuse	N/A	No observations

APPEAL ANALYSIS 2013-14

	<u>Appeal Case</u>	<u>Decision Date</u>	<u>Decision</u>	<u>Appeal Type</u>	<u>Officer Recommendation</u>	<u>Committee Decision</u>	<u>Town Council Response</u>
8	45/2012/1329/PF - 19 West Parade, Rhyl <i>Change of use of existing dwelling to create 3 flats and erection of 2 dormers to rear.</i>	21/08/2013	Dismiss	Written	Refuse	N/A	Object
9	03/2012/0935/PF - Land at rear of 7 Maes Pengwern, Llangollen <i>Outline application for residential development to include means of access</i>	04/10/2013	Dismiss	Written	Refuse	N/A	Object
10	21/2013/0797/PF - Erw Las, Pant Du Road, Eryrys <i>Pitched roof dormer extension at rear and conservatory extension to side</i>	04/12/2013	Allow	Written	Refuse	N/A	No Objection
11	43/2013/0203/PF - 55 Pendre Avenue, Prestatyn <i>Single storey extension to rear</i>	10/12/2013	Allow	Written	Grant	Refuse	Object
12	06/2013/0253/PFT - Llety, Llety Road, Gwyddelwern <i>Single wind turbine with ancillary works (77m height to tip)</i>	15/01/2014	Dismiss	Written	Refuse	Refuse	No observations
13	45/2013/0072/PF - 38 Crescent Road, Rhyl <i>Conversion of dwelling to create 3no. 1 bed apartments</i>	04/03/2014	Allow	Written	Grant	Refuse	Object
14	31/2013/0767/PF - Plas yr Esgob, Glascoed Road, St Asaph <i>Retention of site compound for use as caravan storage area</i>	07/03/2014	Allow	Written	Refuse	Refuse	No observations

APPEAL ANALYSIS 2013-14

	<u>Appeal Case</u>	<u>Decision Date</u>	<u>Decision</u>	<u>Appeal Type</u>	<u>Officer Recommendation</u>	<u>Committee Decision</u>	<u>Town Council Response</u>
15	44/2012/1486/PF - Rear of Bryn Awel, High Street, Rhuddlan <i>Change of use of stores to create 1no. dwelling</i>	07/03/2014	Dismiss	Written	Refuse	N/A	Object
16	43/2013/1321/AD - 79 High Street, Prestatyn <i>3no. externally illuminated fascia signs and 1no. externally illuminated hanging sign</i>	15/04/2014	Dismiss	Written	Refuse	N/A	N/A
17	C01/2012/00332 -Graig Villa, Abrahams Lane, Denbigh. <i>Unauthorised Installation of uPVC window and door</i>	09/05/14	Uphold Enforcement Notice	Written	Serve Enforcement Notice	N/A	N/A
18	C45/2012/00073 127/129 High Street, Rhyl <i>Unauthorised installation of uPVC shopfront</i>	02/05/14	Quash Enforcement Notice	Written	Serve Enforcement Notice	Serve Enforcement Notice	N/A

- Total of 18 planning and enforcement appeal decisions from April 2013 to date
- 13 of those 18 decisions have supported the Council's decision (72%)
- All but 1 appeal was dealt with by the simple written method keeping costs low
- 9 of the 18 appeal cases were borne out of delegated Officer decisions. The other 9 stemmed from decisions made at Committee
- Of the 9 delegated decisions the Council won 8 of the subsequent appeals (89%)
- Of the 9 Committee based decisions the Council won 5 of the subsequent appeals (55%)
- Members followed Officers recommendation on 7 of the 9 Committee based decisions
- Where N/A has been placed in the Town Council response section this is because the types of application submitted did not require consultation with the Town Council under the provisions of the Planning acts.

Mae tudalen hwn yn fwriadol wag